

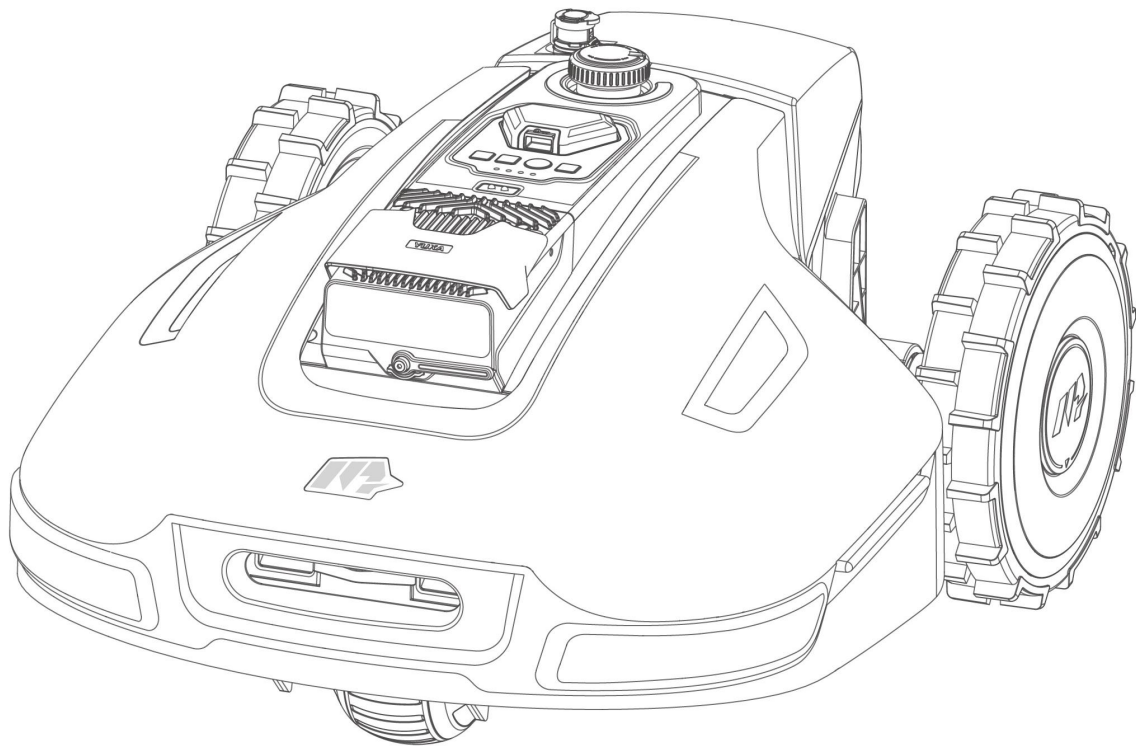

MAMMOTION

USER MANUAL

YUKA 1000/2000/3000



Original Instructions **Version 4.0**

2025.04

Thank you for choosing Mammotion as your garden care lawn mower. This user manual will help you learn and operate Mammotion YUKA, a perimeter-free lawn mower, to cut grass and maintain your lawn.

This manual is copyrighted by Mammotion company. Without the written permission of the company, any unit or individual shall not copy, modify, reproduce, transcribe or transmit in any way or for any reason. This manual is subject to change without notice at any time.

Unless explicitly agreed otherwise, this manual serves solely as a usage guide, and all statements and information contained herein do not constitute any form of warranty.

Revision Log

Date	Version	Description
2025. 01	V1.0	Initial version
2025. 02	V2.0	<ol style="list-style-type: none">1. Section 2.1.9 updated2. Section 2.2.3 updated3. Section 4.3.2 added4. Section 4.7.2 updated5. Section 4.10 updated6. Section 5.2 updated7. Section 6.1 updated
2025. 03	V3.0	<ol style="list-style-type: none">1. Section 2.1.2 updated2. Section 2.3.5 updated3. Section 3.4.4 updated4. Section 4.7.2 updated5. Section 4.10.1 updated6. Section 6.1.1 updated7. Section 6.1.2 updated
2025.04	V4.0	<ol style="list-style-type: none">1. Section 2.3.1 updated2. Section 2.2.3 updated3. Wildlife Safe Mode added4. Section 6.1.1 updated

CONTENTS

1	Safety Instructions	- 1 -
1.1	General Safety Instructions	- 1 -
1.2	Safety Instructions for Installation	- 2 -
1.3	Safety Instructions for Operation	- 2 -
1.4	Safety Instructions for Maintenance	- 3 -
1.5	Battery Safety	- 4 -
1.6	Residual Risks	- 4 -
1.7	Intended Use	- 4 -
1.8	Disposal	- 4 -
2	Introduction	- 5 -
2.1	About Mammotion YUKA	- 5 -
2.2	Product Overview	- 9 -
2.3	In the Box	- 15 -
2.4	Symbols on the Product	- 18 -
3	Installation	- 20 -
3.1	Preparation	- 20 -
3.2	Choosing a Location for RTK Reference Station	- 20 -
3.3	Choosing a Location for Charging Station	- 22 -
3.4	Install	- 23 -
4	Operation	- 32 -
4.1	Preparation	- 32 -
4.2	Download Mammotion App	- 32 -
4.3	Add Your Product	- 33 -
4.4	Activate SIM Card	- 35 -
4.5	Update Firmware	- 35 -
4.6	Create a Map	- 36 -
4.7	Mow and Sweep	- 49 -

4.8	Task Schedule	- 57 -
4.9	Manual Operation	- 59 -
4.10	View Status	- 62 -
4.11	Settings	- 72 -
4.12	Service Page	- 76 -
4.13	Me Page	- 76 -
5	Maintenance	- 84 -
5.1	Cleaning	- 84 -
5.2	Maintenance for Cutting Blades and Motor	- 86 -
5.3	Battery Maintenance	- 88 -
5.4	Winter Storage	- 88 -
6	Product Specifications	- 91 -
6.1	Technical Specifications	- 91 -
6.2	Fault Codes	- 95 -
7	Warranty	- 97 -
8	Compliance	- 99 -

1 Safety Instructions

1.1 General Safety Instructions

- Carefully read and understand the user manual before using the robot.
- Only individuals who are legally considered adults in their state of residence are recommended to use the robot.
- Only use the equipment recommended by Mammotion with the robot. Any other usage is incorrect.
- Never allow children, persons with reduced physical, sensory or mental capabilities or lack of experience and knowledge or people unfamiliar with these instructions to use the robot, local restrictions may restrict the age of the operator.
- Do not allow children to be in vicinity or play with the robot when it is operating.
- Do not use the robot in areas where people are unaware of its presence.
- When manually operating the robot with the Mammotion app, do not run. Always walk, watch your steps on slopes, and maintain balance at all times.
- Avoid touching moving hazardous parts, such as the blade disc, until it has completely stopped.
- Avoid using the robot when there are people, especially children or animals, in the task area.
- If operating the robot in public areas, place warning signs around the task area with the following text:
"Warning! Automatic lawn mower! Keep away from the robot! Supervise children!"
- Wear sturdy footwear and long trousers when operating the robot.
- To prevent damage to the robot and accidents involving vehicles and individuals, do not set task areas or channels across public pathways.
- Seek medical aid in case of injury or accidents.
- Set the robot to **OFF** and remove the security key before clearing blockages, performing maintenance, or examining the robot. If the robot vibrates abnormally, inspect it for damage before restarting. Do

not use the robot if any parts are defective.

- Do not connect or touch a damaged cable until it is disconnected from the power outlet. If the cable becomes damaged during operation, disconnect the plug from the power outlet. A worn or damaged cable increases the risk of electrical shock and should be replaced by service personnel.
- Do not place cables in areas where the robot will cut.
- Only use the charging station included in the package to charge the robot. Incorrect use may result in electric shock, overheating, or corrosive liquid leakage from the battery. In case of electrolyte leakage, flush with water/neutralizing agent and seek medical aid if the corrosive liquid comes into contact with your eyes.
- Only use original batteries recommended by Mammotion. The safety of the robot cannot be guaranteed with non-original batteries. Do not use non-rechargeable batteries.
- Keep extension cords away from moving hazardous parts to avoid damage to the cords which can lead to contact with live parts.
- The illustrations used in this document are for reference only. Please refer to the actual products.

1.2 Safety Instructions for Installation

- Avoid installing the charging station in areas where people may trip over it.
- Do not install the charging station in areas where there is a risk of standing water.
- Do not install the charging station, including any accessories, within 60 cm/24 in of any combustible material. Malfunctioning or overheating of the charging station and power supply can pose a fire hazard.
- For users in the USA/Canada: If installing the power supply outdoors, there is a risk of electric shock. Only install it in a covered Class A GFCI receptacle (RCD) with a weatherproof enclosure, ensuring that the attachment plug cap is inserted or removed.

1.3 Safety Instructions for Operation

- Keep your hands and feet away from the rotating blades. Do not place your hands or feet near or

below the product when it is turned on.

- Do not lift or move the product when it is turned on.
- Ensure that there are no objects such as stones, branches, tools, or toys on the lawn. Otherwise, the blades may be damaged when they come into contact with the object.
- Do not put objects on top of the product, charging station or RTK reference station.
- Do not use the product if the **STOP** button is not functioning.
- Avoid collisions between the product and people or animals. If a person or animal comes in the path of the product, stop it immediately.
- Always power off the robot when it is not in operation.
- Do not use the product simultaneously with a pop-up sprinkler. Utilize the Schedule function to ensure that the product and pop-up sprinkler do not operate at the same time.
- Avoid setting a channel where pop-up sprinklers are installed.
- Do not operate the product in the presence of standing water in the task area, such as during heavy rain or water pooling.

1.4 Safety Instructions for Maintenance

- Turn off the robot when performing maintenance.
- Disconnect the plug from the charging station before cleaning or performing maintenance on the charging station.
- Do not use a high-pressure washer or solvents to clean the robot.
- After washing, ensure that the robot is placed on the ground in its normal orientation, not upside down.
- Do not reverse the robot to wash the bottom. If you do reverse it for cleaning purposes, make sure to restore it to its proper orientation afterward. This precaution is necessary to prevent water from leaking into the motor and potentially affecting normal operation.

1.5 Battery Safety

Lithium-ion batteries can explode or cause a fire if disassembled, short-circuited, or exposed to water, fire, or high temperatures. Handle them with care, do not dismantle or open the battery, and avoid any form of electrical/mechanical abuse. Store them away from direct sunlight.

- Only use the battery charger and power supply provided by the Manufacturer. The use of an inappropriate charger and power supply can cause electric shocks and/or overheating.
- DO NOT ATTEMPT TO REPAIR OR MODIFY BATTERIES! Repair attempts may result in severe personal injury, due to explosion or electrical shock. If a leak develops, released electrolytes are corrosive and toxic.
- This appliance contains batteries that are only replaceable by skilled persons.

1.6 Residual Risks

To avoid injuries, wear protective gloves when replacing the blades.

1.7 Intended Use

Mammotion robots are designed for residential lawn care and are not intended for commercial use.

1.8 Disposal

Dispose of this product in compliance with local electronic waste (WEEE) regulations. Do not dispose of it with regular household waste. Instead, bring it to an authorized recycling center or collection point to ensure safe handling and environmentally responsible disposal of electronic components.

2 Introduction

2.1 About Mammotion YUKA

The YUKA Series Perimeter Wire Free Robot Lawn Mower, known as YUKA, boasts dual cutting discs for efficient mowing. It utilizes floating cutting discs to ensure precise cuts across diverse terrains and features a U-shape bumper for improved maneuverability and protection.

Equipped with a lawn sweeper kit, YUKA excels in simultaneous mowing and sweeping, maintaining a pristine lawn effortlessly. Its advanced positioning is driven by a state-of-the-art UltraSense AI Vision and RTK fusion-mapping system, enabling precise navigation and mapping without the need for perimeter wires.

Ideal for homeowners seeking efficient and perimeter-free lawn maintenance, YUKA sets a new benchmark in automated mowing technology.

2.1.1 About Vision Module

YUKA is equipped with a vision module that provides vision positioning, vision obstacle detection, and FPV mode.

- Vision positioning helps to guarantee positioning accuracy when RTK positioning fails due to poor satellite signals.
- Vision obstacle detection identifies obstacles in the front.
- FPV mode can be used for monitoring as a security camera.

2.1.2 About Positioning

YUKA is built in an RTK (real-time kinematic) navigation system, a multi-sensor integrated navigation system, and a vision positioning system, which provide more accurate positioning data.

RTK Positioning

RTK is a differential GNSS positioning technology that greatly enhances positioning accuracy to approximately 5 cm (2 in). YUKA accesses four global navigation systems (GPS, GLONASS, BeiDou, and Galileo) and incorporates supplementary sensors, thus, providing nearly 100 times improved accuracy than conventional GPS systems.

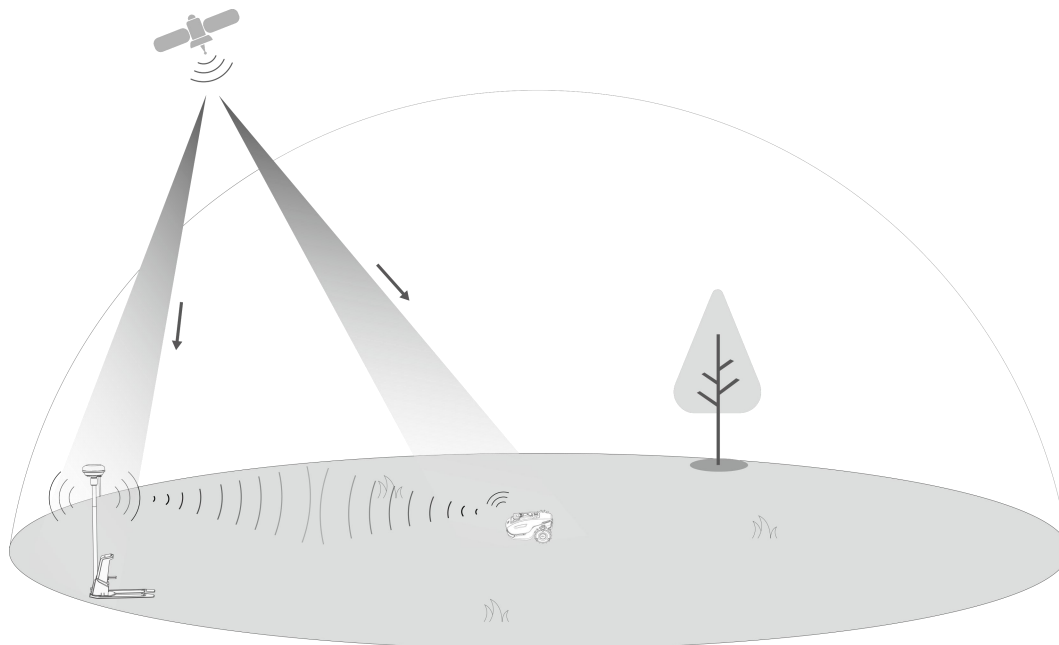

- The GNSS (GPS, GLONASS, BeiDou, and Galileo) satellites provide initial positioning information to both the RTK reference station and the robot.
- The RTK reference station continuously receives satellite signals, corrects the positioning errors, and transmits the corrected data to the robot via wireless communication.
- The robot receives GNSS signals from satellites and error-corrected data from the RTK reference station, enabling it to achieve high-precision positioning for automated mowing over large areas.
- The antenna on the RTK reference station enables wireless data transmission between the RTK reference station and the robot, ensuring the robot receives accurate positioning data in real time.

Vision Positioning

YUKA primarily uses RTK positioning to locate itself. However, in situations where satellite signals are obstructed by obstacles such as eaves or trees during mapping and mowing, YUKA can still operate effectively using the vision positioning.

2.1.3 About Obstacles Detection

YUKA identifies obstacles through vision module and the U-shape bumper. The vision system can identify obstacles and respond accordingly.

2.1.4 About Lawn Art Printing

By utilizing AI algorithms to tailor the cutting path, cutting height, and angle, YUKA can create special patterns via the Mammotion app. See [Create a Pattern](#) for more information.

2.1.5 About Self-emptying Lawn Sweeper Kit (sold separately)

Equipped with the self-emptying lawn sweeper kit, YUKA efficiently gathers grass clippings, leaves, and debris during mowing operations, autonomously disposing of them at the designated location.

2.1.6 About Connectivity

YUKA supports three methods of connectivity, namely, Bluetooth, Wi-Fi, and 4G cellular data. Bluetooth is used to connect YUKA with your phone, while Wi-Fi and 4G cellular data are used to access the internet.

2.1.7 About Voice Control



NOTE

The robot now supports voice commands in English, German, and French.

YUKA is compatible with both Alexa and Google Home voice control. Once linked, you can easily start or stop working or recharging using simple voice commands. See [Link Your Alexa Account](#) or [Link Your Google Home Account](#) for more information.

2.1.8 About Auto-recharge

YUKA supports automatically returning to charge when the battery is lower than 15%.

2.1.9 About Anti-theft System

- Currently, you will receive a push notification through the Mammotion app if your robot exceeds the defined area. See [Find My Device](#) for more information.
- Users can track YUKA's location by GPS and 4G positioning through the Mammotion app, as long as it is online. See [Find My Device](#) for more information.
- Additionally, YUKA's rear wheels allow for an AirTag to be attached to track its location.

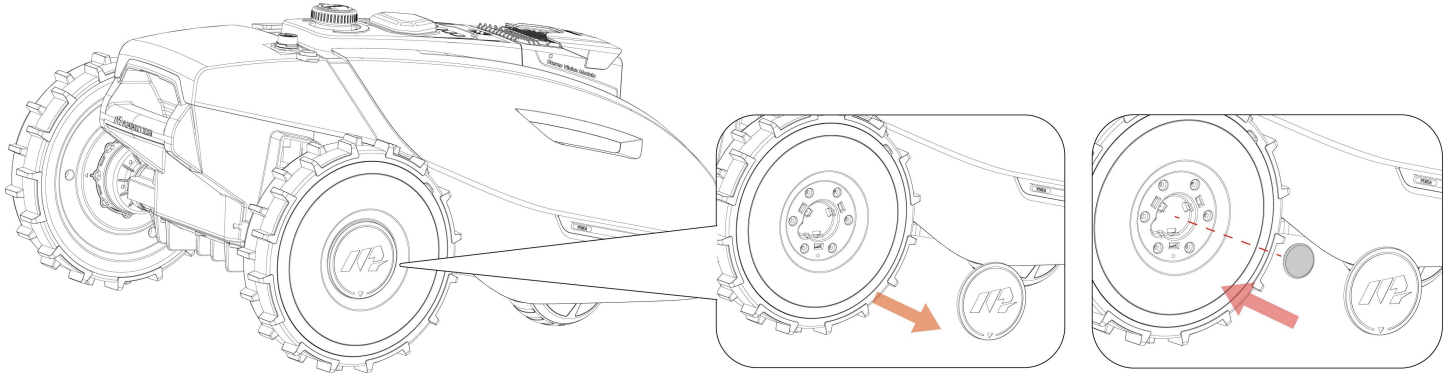

2.2 Product Overview



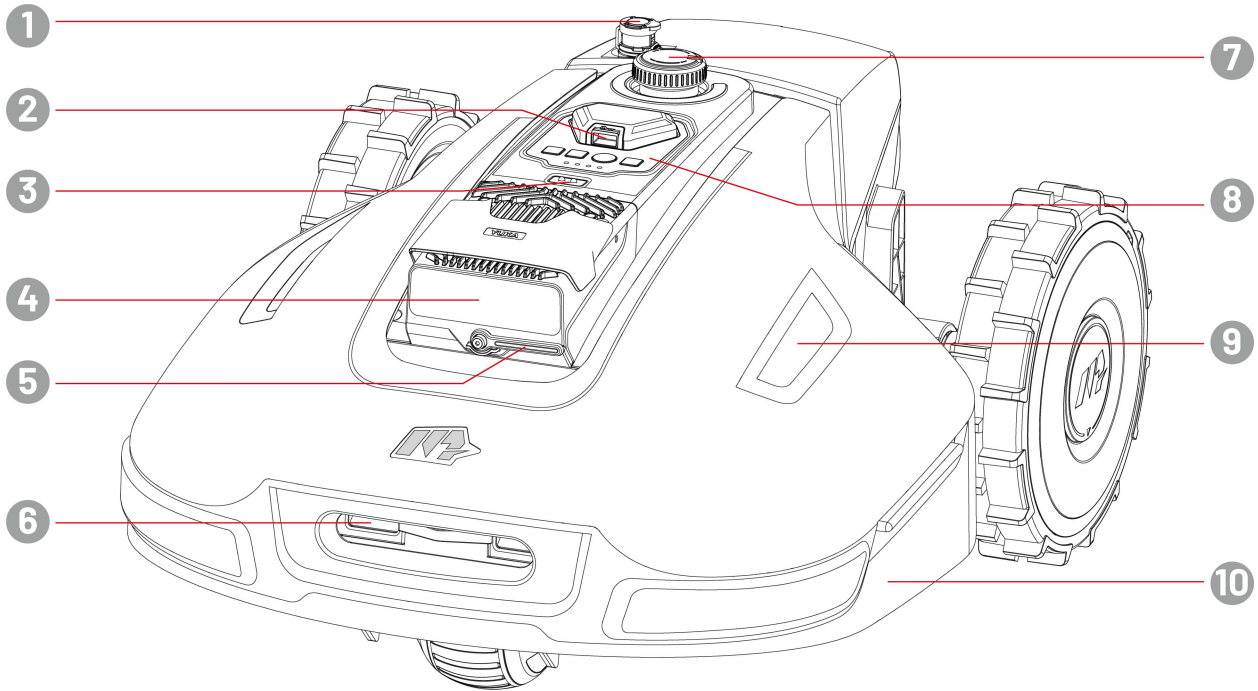





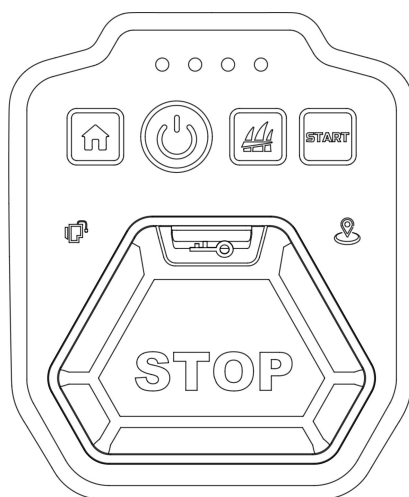



2.2.1 YUKA



- | | |
|---|--------------------|
| 1. Port for Sweeper Kit | 2. Security Key |
| 3. Rain Sensor | 4. Vision Module |
| 5. Vision Module Wiper | 6. Charging Pad |
| 7. Cutting Height Adjustment Button — press and turn to adjust cutting height | 8. Control Center |
| 9. Side LED | 10. U-shape Bumper |

Control Center



Button/Icon	Description	Description
	Home Button	<ul style="list-style-type: none"> ● Press  , then press  to return to the charging station. ● Press  , then press  to continue working/unlock the robot.
	Grass Button	
	Start Button	
	Power Button	Long press the button  to turn on/off the robot.
	Emergency Stop Button	If any unexpected problems arise, press the button to stop the robot immediately.
	Positioning Indicator	Indicates the positioning status. See LED Indicator Codes for more information.
	Sweeper Kit Indicator	Indicates the connection status of the sweeper kit.
	Battery Indicator	Indicates the robot's battery.

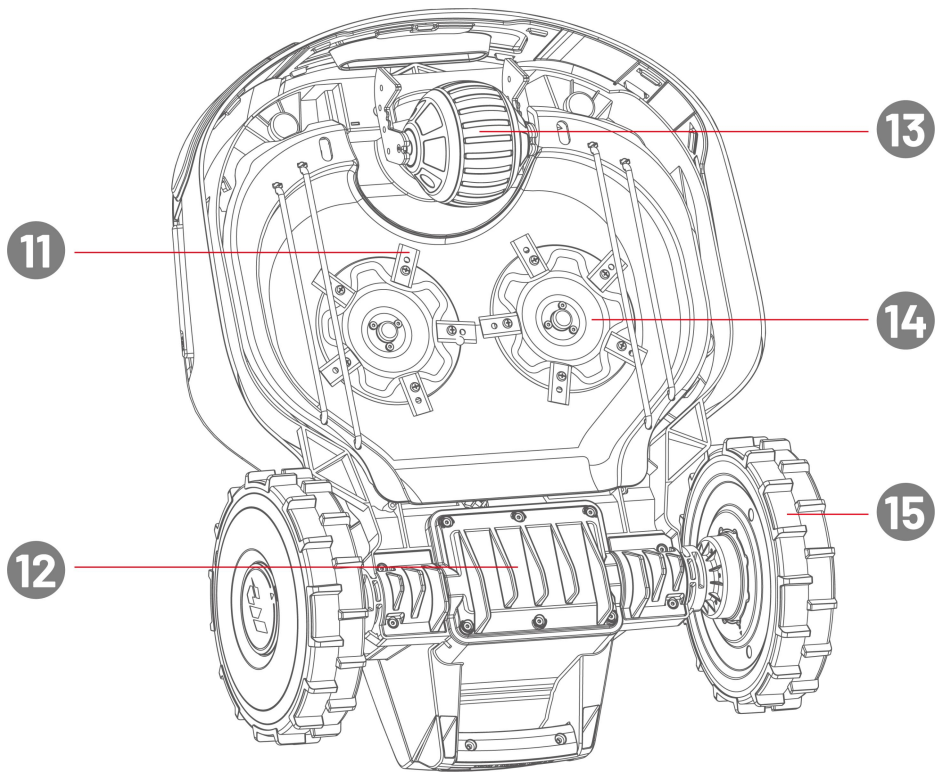

11. Cutting Blade

13. Omni Wheel

15. Rear Wheel

12. Battery Compartment

14. Cutting Disc

2.2.2 Charging Station and RTK Reference Station

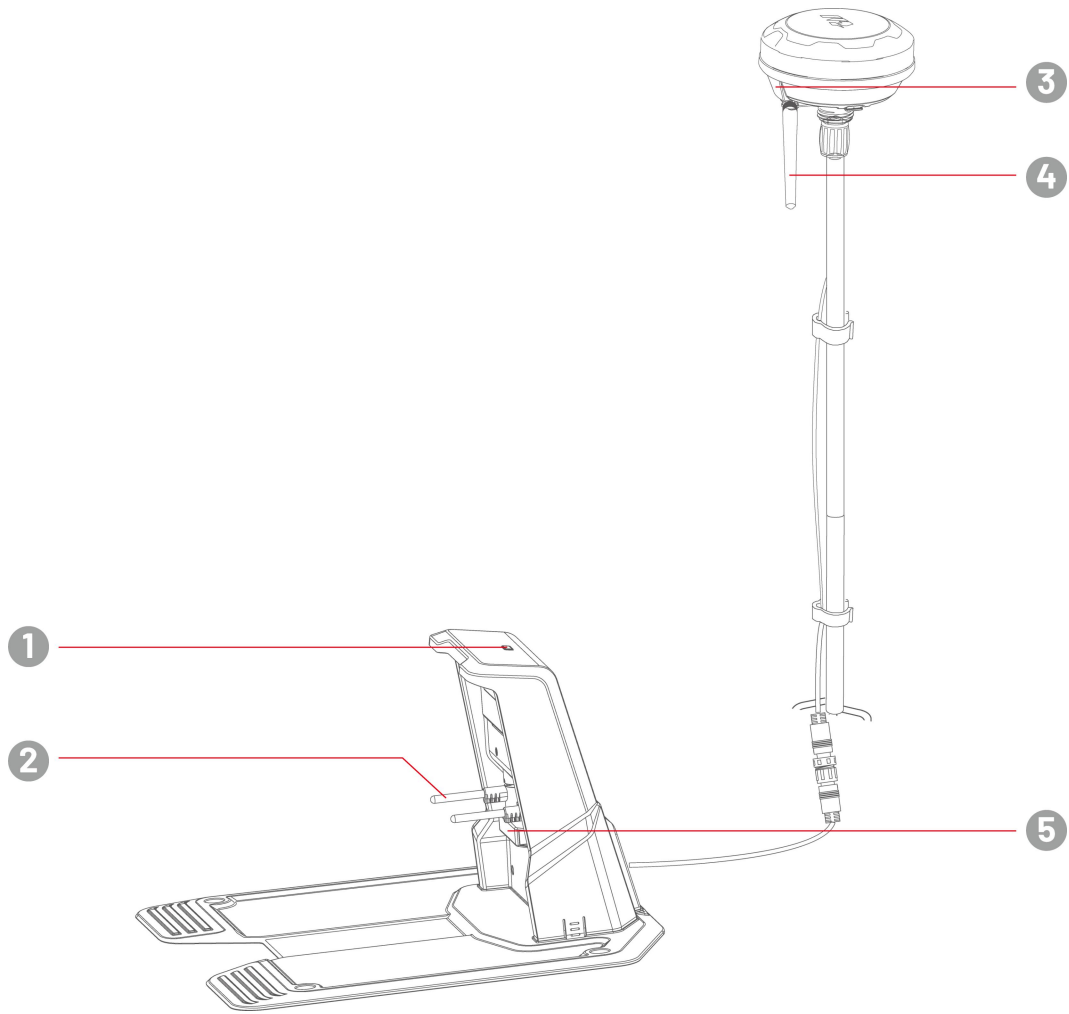

1. Charging Station LED Indicator

3. RTK Reference Station LED Indicator

5. Infrared Transmitter

2. Charging Pin

4. Radio Antenna

2.2.3 LED Indicator Codes

YUKA

Indicator	Color	Description
Side LED	Solid green	The robot is functioning properly.
	Breathing green	<ul style="list-style-type: none"> ● OTA upgrade in progress ● The robot is being charged
	Blinking blue	<ul style="list-style-type: none"> ● Emergency Stop Button activated ● Low battery ● The robot got stuck ● Security key not properly installed. ● The robot has been lifted/tilted/flipped over
	Solid red	<ul style="list-style-type: none"> ● The robot system malfunction ● The robot system upgrade failed
	Off	<ul style="list-style-type: none"> ● The robot is turned off ● The robot is sleeping ● The side LED is turned off in the app ● The robot is in manual control mode but is currently inactive
Positioning Indicator	Solid green	The positioning is working well.
	Blinking red	The positioning system malfunction.
	Blinking blue	The positioning system is initializing.
	Solid blue	The robot is powered on successfully.

Charging Station

Color	Description
Blinking green	The robot is docked at the charging station.
Solid green	The robot is not at the charging station.
Solid red	The charging station malfunction.
Off	No power supply

RTK Reference Station

Color	Description
Blinking blue	The reference station is being upgraded.
Blinking green	The reference station is initializing.
Solid green	The positioning mode is set to Antenna over Datalink and is functioning well.
Solid blue	The positioning mode is set to Antenna over Internet and is functioning well.
Off	<ul style="list-style-type: none">● The local time is between 18:00 and 8:00.● No power supply.
Solid red	The RTK reference station malfunction

2.3 In the Box

Ensure the parts can be found in the package according to your order. If any parts are missing or damaged, contact your local dealer or our after-sales support. Mammotion recommends you keep the package box and foam inserts for future use.

2.3.1 YUKA Installation Kit

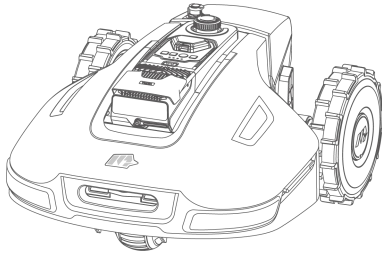

YUKA x1



Security Key x1 (for spare use)

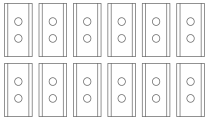

Blade x12 (for spare use)



Screw x12 (for spare use)

2.3.2 Charging Station Installation Kit

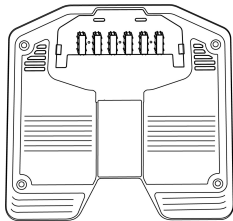

Charging Base Plate x1

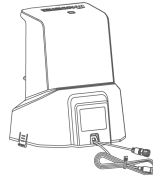

Charging Tower x1

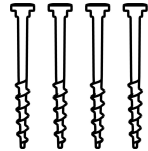

Stake x4



Screw x4 (1 pc for spare use)

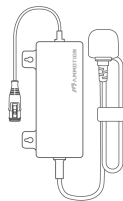

Charging Station Power Supply x1

2.3.3 RTK Installation Kit



RTK Reference Station x1



Radio Antenna x1



Trident Ground Stake x1

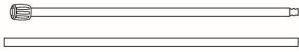

Mounting Pole x2

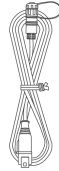

RTK Reference Station Extension Cable (5M) x1

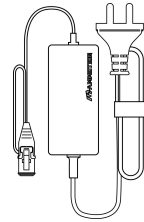

RTK Reference Station Power Supply x1

2.3.4 Tool Kit



Allen Key 8mm x1

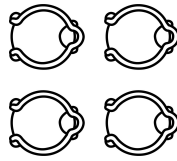

Cord Tie x4

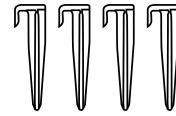

Cable Peg x4

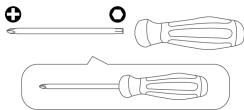

Screwdriver (Phillips bit+2.5mm hex bit) x1



Allen Key 1.5mm x1

2.3.5 Other Accessories (Optional)

The following accessories are sold separately.

RTK Reference Station Wall Mount Kit

By using the wall mount kit, the RTK reference station can be securely installed on a wall, enhancing its satellite signal reception.

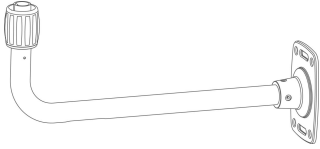

RTK Wall Mount x1

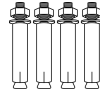

M8x50 Expansion Bolt x4

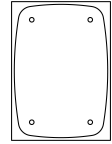

Drilling Template x1

Lawn Sweeper Kit

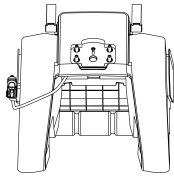

Sweeping Brush Module x1

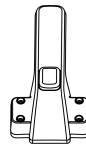

Handle Module x1



Screw x6 (2pcs for spare use)

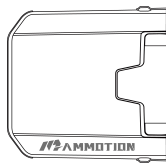

Hopper Cover x1

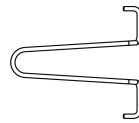

Hopper Handle x1

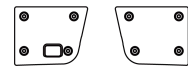

Hold-down Plate x2

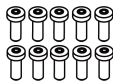

Screw x8 (2pcs for spare use)

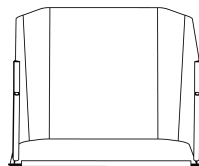

Hopper x1



U-shaped Supporting Rod x1

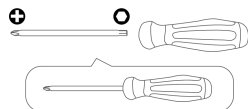

**Screwdriver (Phillips bit+2.5mm hex bit)
x1**





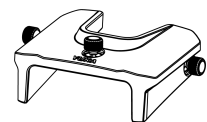







Battery x1

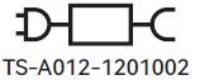









Counterweight Part x1

2.4 Symbols on the Product

These symbols can be found on the product. Study them carefully.

Symbol	Description
	Warning.
	Read user instructions before operating the product.
	Use a detachable supply unit TS-A081-2703002.
	Use a detachable supply unit TS-A012-1201002.
	This product complies with the applicable EU Directives.
Made in China	This product is manufactured in China.
	It is not permitted to dispose of this product as normal household waste. Ensure that the product is recycled in accordance with local legal requirements.
	This item can be recycled.
	Keep the pack of this product dry.
	The pack of this product should not be covered.
	Prohibit flipping.
	This product is fragile.
	The pack of this product/the product should not be tread.

Symbol	Description
	Class III appliance.
	Keep hands or feet away from movable blades.
	Do not ride on the machine.
	Keep a safe distance from your machine when operating.
	WARNING - Do not touch rotating blade.
	WARNING - Read the user instructions before operating the product.
	WARNING - Danger of projections of objects against the body. Keep an adequate safe distance from the machine while it is running.
	WARNING - Remove the disabling device before working on or lifting the machine.
	WARNING - Do not ride on the machine. Never put your hands or feet close to or under the machine.

3 Installation

3.1 Preparation

- Read and understand the safety instructions prior to installation.
- Use original parts and installation materials.
- Sketch your lawn and mark up obstacles. This will make it easier to examine where to place the charging station and RTK reference station, and to set the virtual boundaries.

3.2 Choosing a Location for RTK Reference Station

To optimize the performance of the RTK system, the RTK reference station must be in an open area to receive satellite signals. You can install the RTK reference station on flat, open ground or on an unobstructed wall or roof. In general, if your lawn is L-shaped (A), you can place the RTK reference station on a wall or roof or on the ground; if your lawn is O-shaped (C) or U-shaped (B), or if you have multiple lawns (D), we recommend that you place the RTK reference station on a wall or roof.

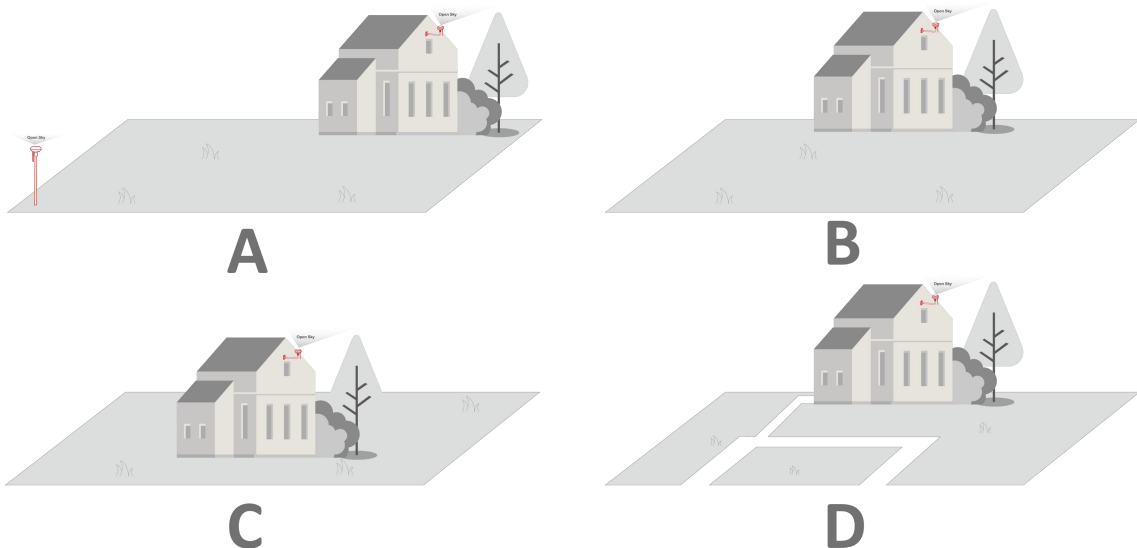

The location requirements are as follows:

- The RTK reference station should be oriented vertically, as shown below:

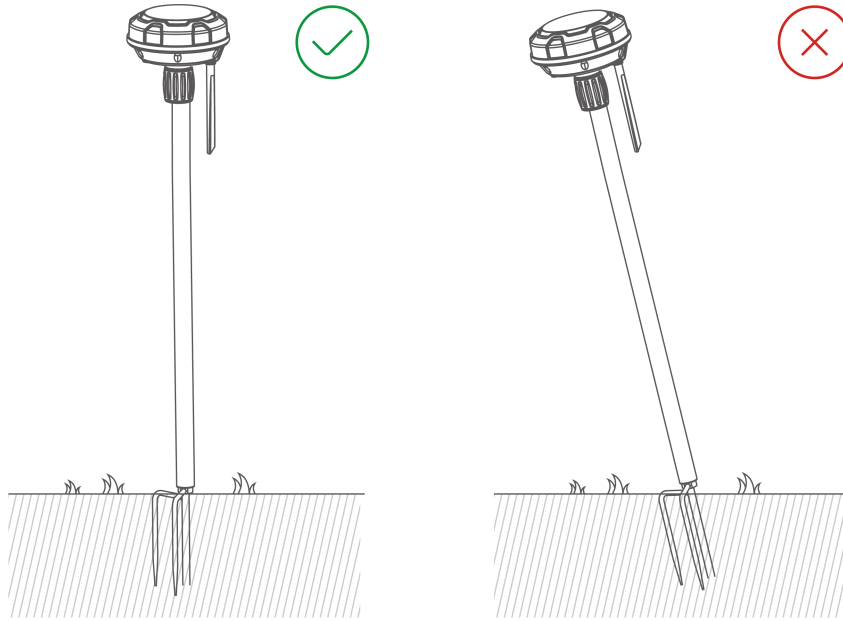

- Place the RTK reference station on a flat, open ground or on an unobstructed wall or roof. Make sure there are no roofs or trees that may obstruct the satellite signals.
- Maintain a distance of at least 3 meters (10 feet) between the RTK reference station and any wall or tree.

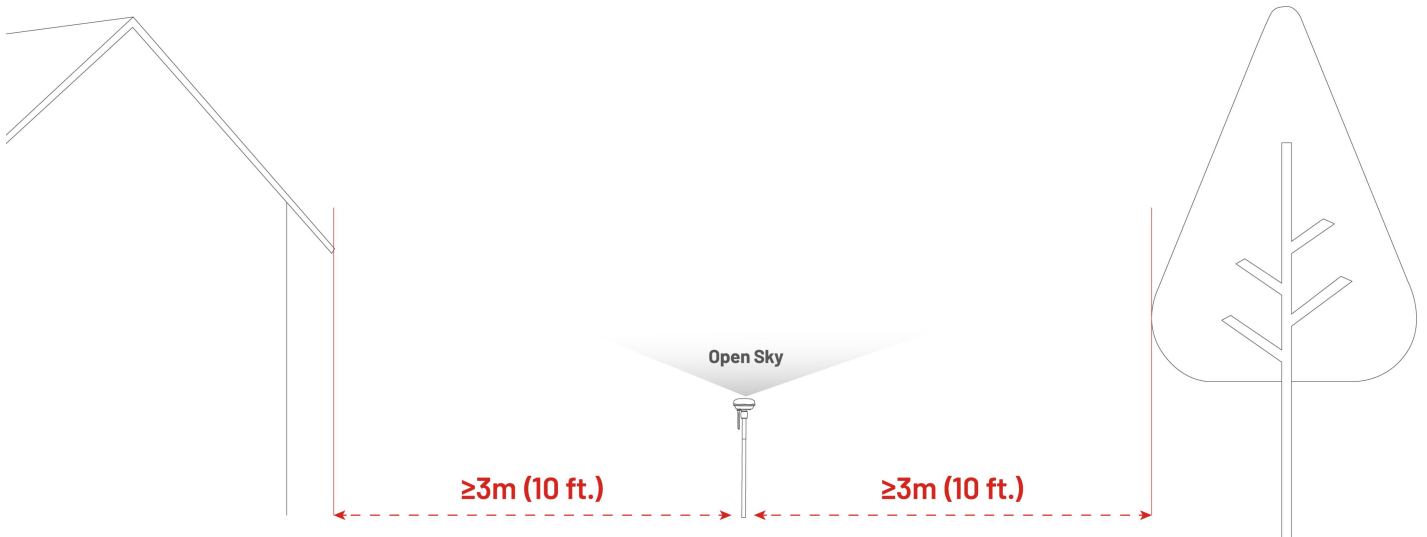

3.3 Choosing a Location for Charging Station

- Place the charging station on a flat ground.
- The charging area (1x1 m/3x3 feet in front of the charging station) should be free from significant bumps. The slope must be less than 5° .
- DO NOT install the charging station at the corner of an L-shaped building or on a narrow path between two structures.
- No obstacles or other items should be between the charging station and the docking point.
- The base plate of the charging station must remain flat and not be bent or tilted.

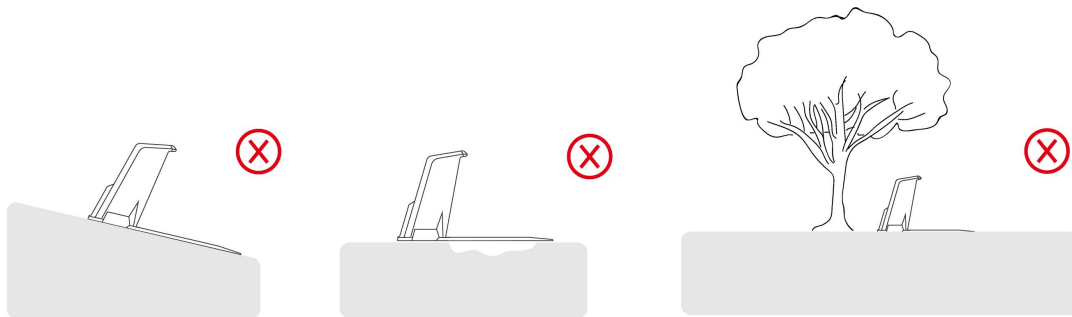

- Position the charging station to face the lawn.

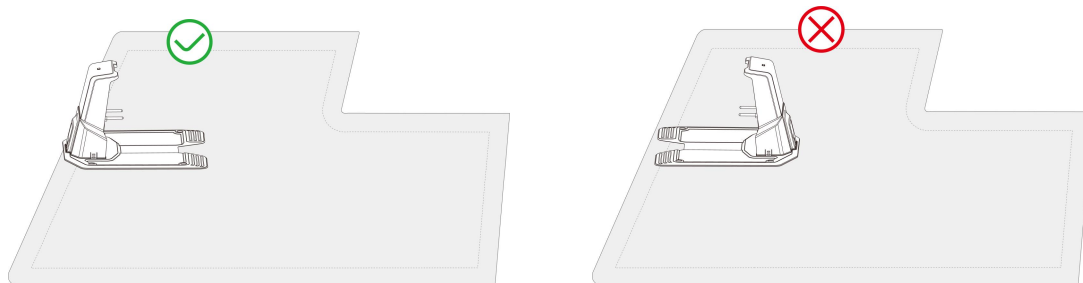

- If the charging station is placed outside the lawn, create a channel to connect it to the lawn.

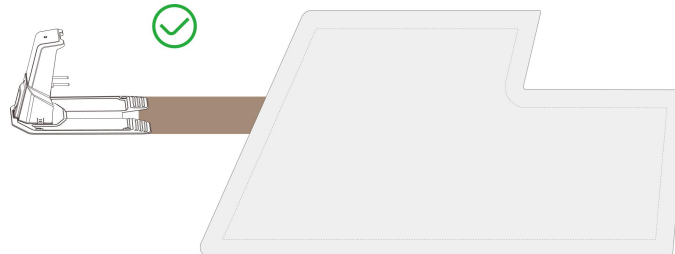

NOTE

If the charging station is installed on a concrete surface, please secure it with expansion bolts.

3.4 Install

Before installing, remove the packaging foam from the bottom of the YUKA as shown in the label.

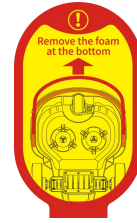

3.4.1 Install the Charging Station

1. Insert the charging tower into the charging base plate until you hear a CLICK sound.

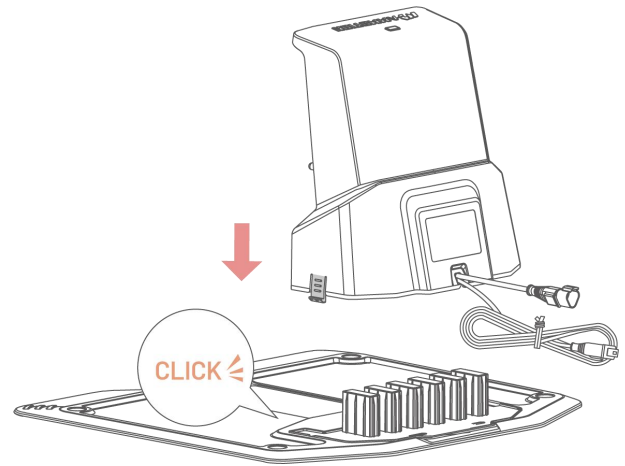

2. Install and tighten the three screws from the bottom of the charging base plate using the screwdriver with the 2.5mm (0.1 in) hex bit.

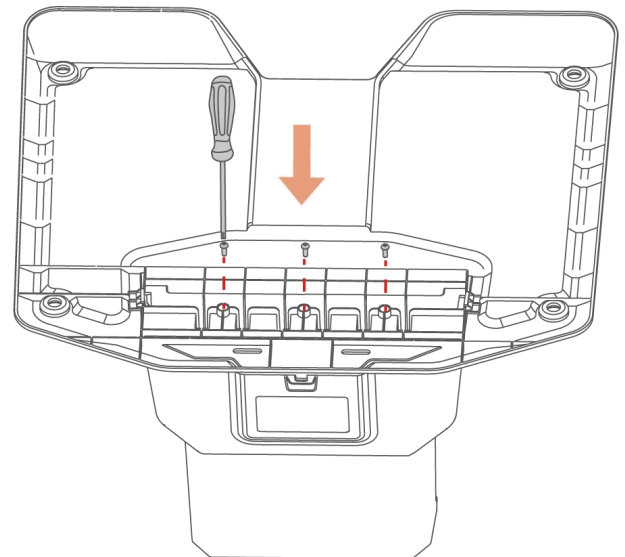

3. Select an open spot to install the charging station, ensuring its front area is clear of obstacles.
4. Secure the charging station in place using the four stakes and the 8 mm (0.3 in) Allen key.
5. Connect the charging station cable (the longer one) with the power supply.
6. Plug the charging station power supply into the wall socket.
7. Place the robot on the charging station to begin charging.

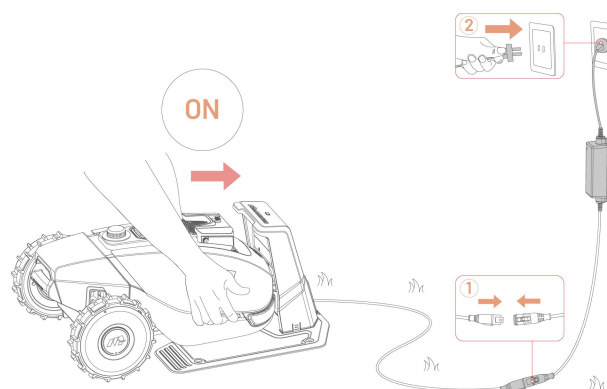
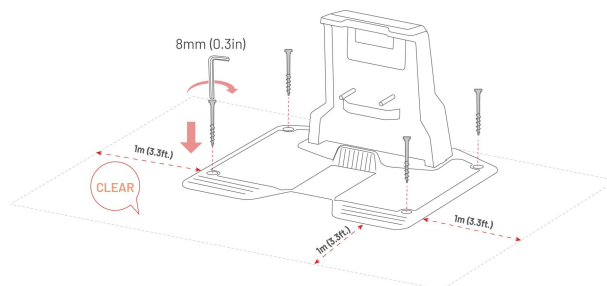

NOTE

Charge the robot for initial use to activate it.

3.4.2 Install the RTK Reference Station (Floor Mount)

1. Assemble the two mounting poles and the trident ground stake.

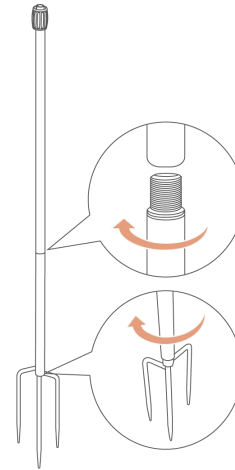

2. Fix the radio antenna to the RTK reference station.

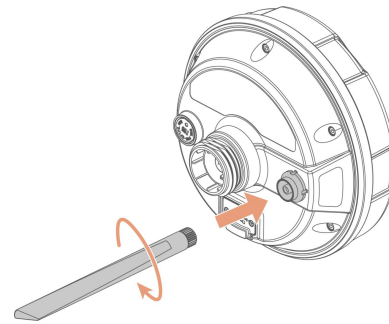

3. Route the RTK reference station cable into the mounting pole as shown.
4. Mount the RTK reference station on the mounting pole.

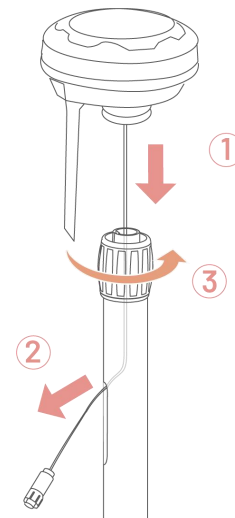

- 5.** Thrust the mounting pole into the ground close to the charging station.

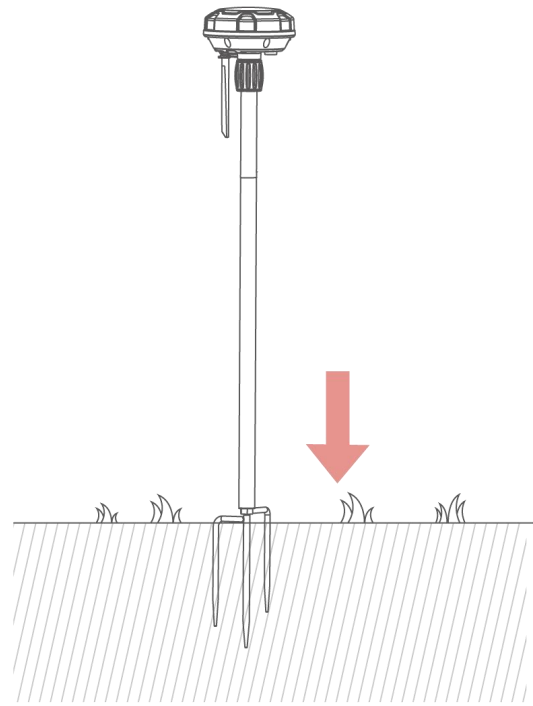

- 6.** Connect the RTK reference station cable with the charging station cable (the shorter one).
- 7.** Use the cord tie and cable peg to neatly secure the cables in place.

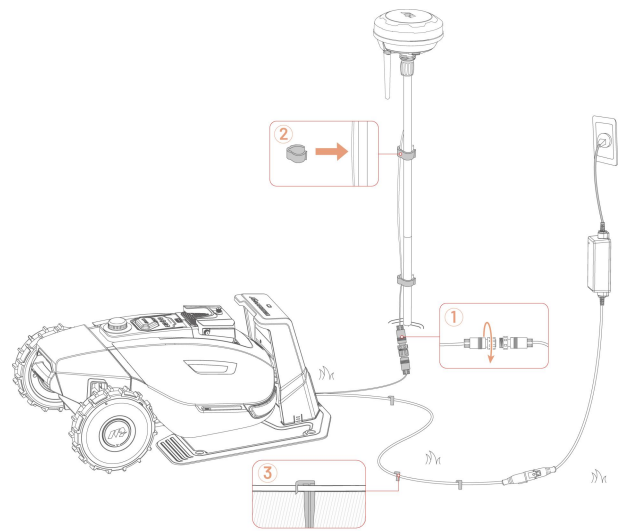

3.4.3 Install the RTK Reference Station (Wall Mount)

NOTE



- The RTK wall mount kit is sold separately.
- Skip section 3.4.2 if you install the RTK reference station on a wall.

1. Choose a suitable installation area at a high place of your house.
2. Stick the drilling template on the wall and drill four holes (10 x 40mm/0.4 x 1.6 in) at the appropriate position.
3. Tap the four expansion bolts into the drilled holes, then unscrew the nuts and washers once the threaded rods are secure.
4. Attach the RTK wall mount kit to the wall using the washers and nuts, and tighten the nuts securely.

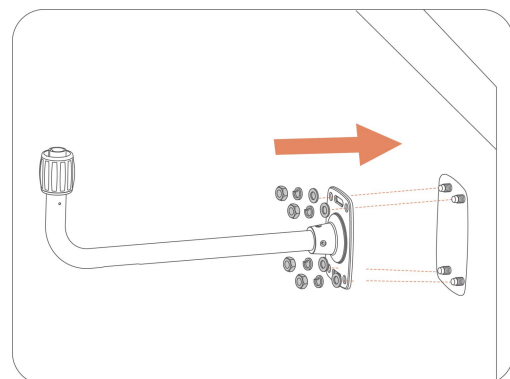
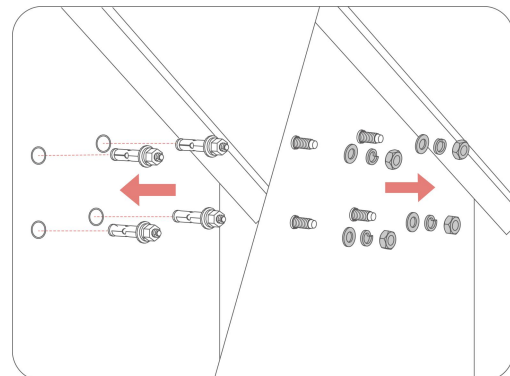
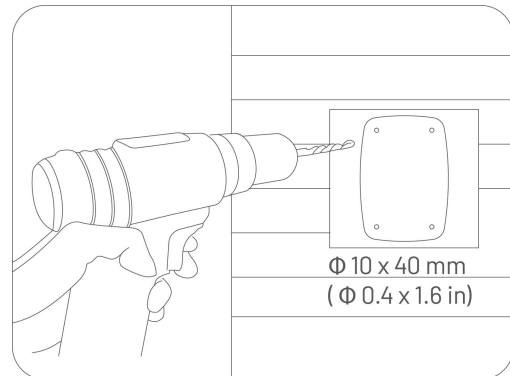

5. Route the RTK reference station cable into the wall mount kit.

6. Attach the RTK reference station to the wall mount kit.

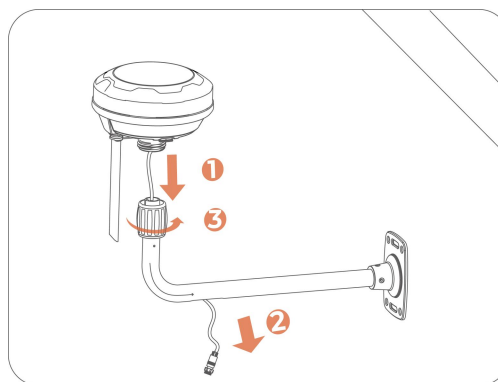

7. Connect the RTK reference station plug to the RTK reference station extension cable (5 m/16.5 feet).

8. Connect the RTK reference station cable (5 m/16.5 feet) to the RTK reference station power supply.

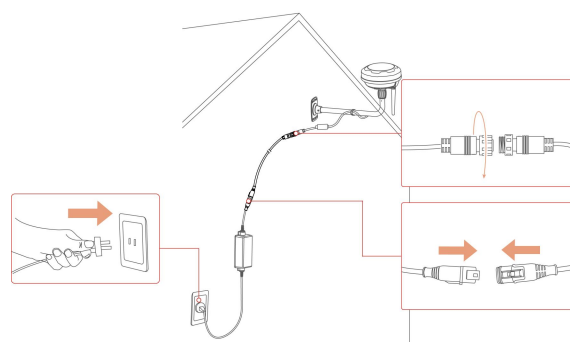

9. Plug the power supply into a wall socket.

3.4.4 Install the Lawn Sweeper Kit (Optional)

Please follow the instructions below to install the lawn sweeper kit if any.



NOTE

The YUKA 3000 model can skip the following steps 1-3.

1. Use the screwdriver with the 2.5mm (0.1 in) hex bit to loosen the 6 screws to detach the battery cover at the bottom of the robot.

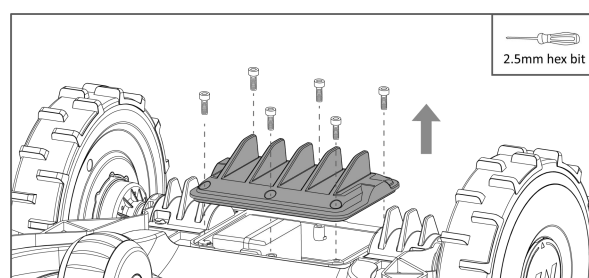

2. Connect the battery wires and use the two screws to secure the battery. Tighten the screws using the screwdriver with the 2.5mm (0.1 in) hex bit.

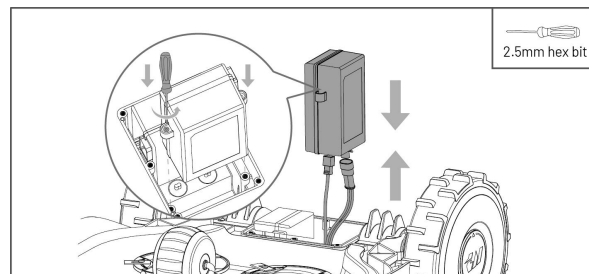

3. Reinstall the battery cover.

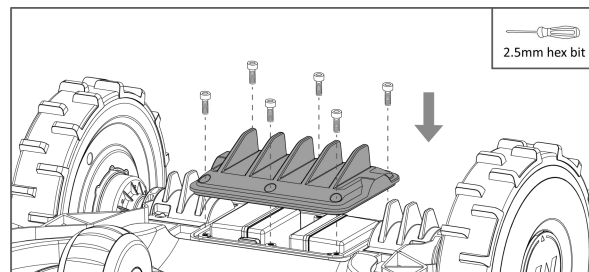

4. Install the handle module on top of the sweeping brush module and tighten the 4 screws using the screwdriver with the 2.5mm (0.1 in) hex bit.

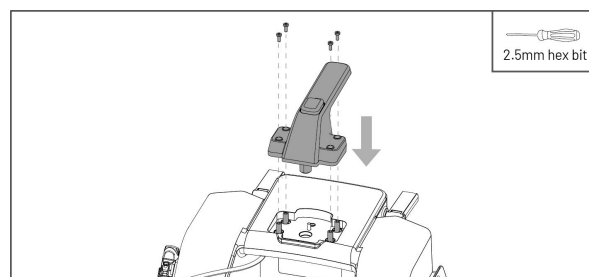

5. Mount the hopper handle as indicated in the provided picture.

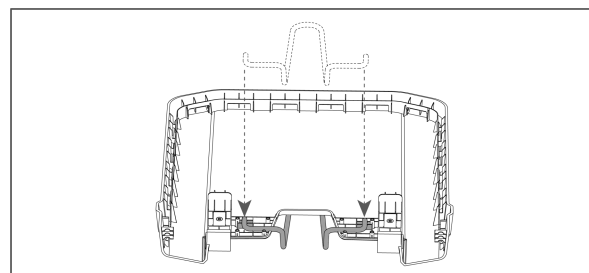

6. Attach the two hold-down plates to secure the hopper handle in place. Tighten the 8 screws using the screwdriver with the 2.5mm (0.1 in) hex bit. Note that the torque should not be over 5 N·m.

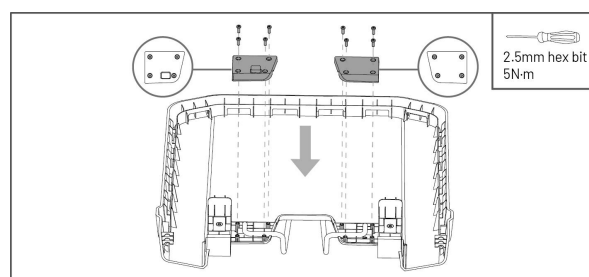

- 7.** Embed the hopper into the hopper cover securely and gently pull both ends to adjust alignment.

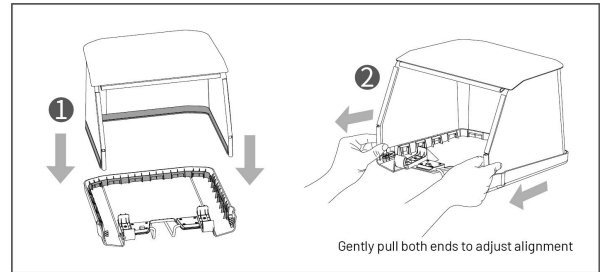

- 8.** Insert the U-shaped supporting rod into the hopper.

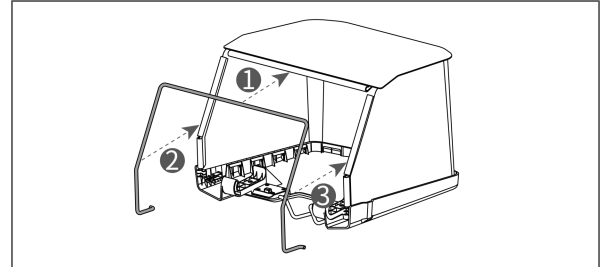

- 9.** Securely insert both ends of the U-shaped support rod into their designated positions.

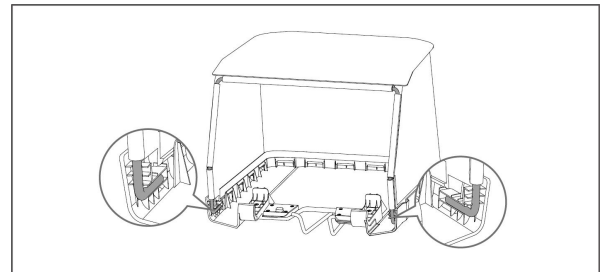

- 10.** Mount the sweeping brush module onto the robot.

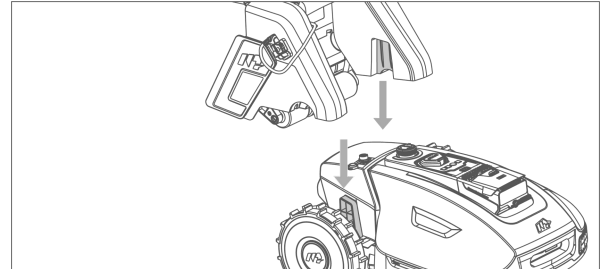

- 11.** Attach the hopper module to the sweeping brush module.

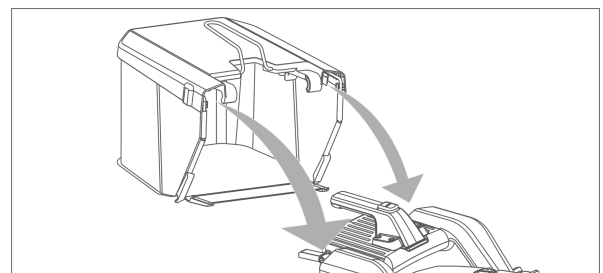

12. Connect the sweeper plug to the robot.

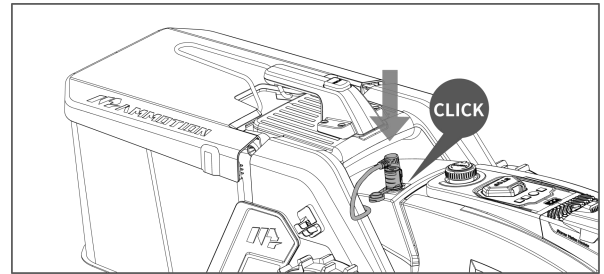

13. Use a tool to detach the vision module cover carefully.

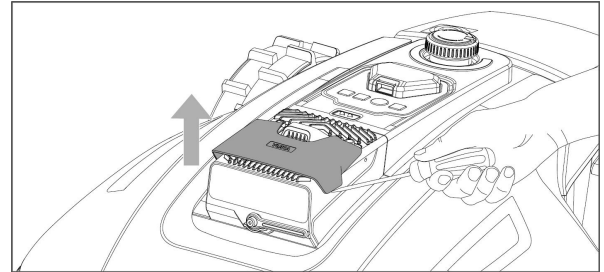

14. Attach the counterweight part onto the vision module.

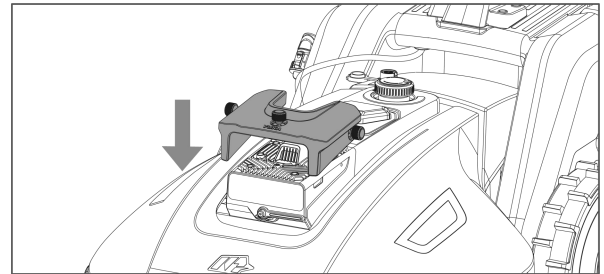

15. Tighten the screws securely.

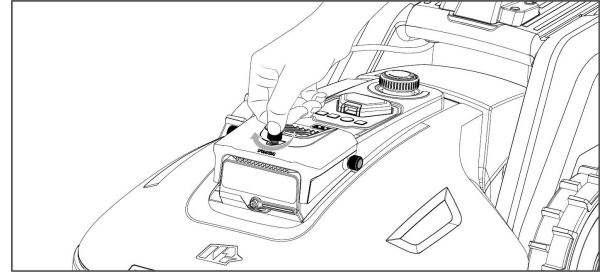

Uninstall the Lawn Sweeper Kit (for maintenance)

1. Disconnect the plug from the robot.
2. Press the button and lift the handle to detach the lawn sweeper kit.

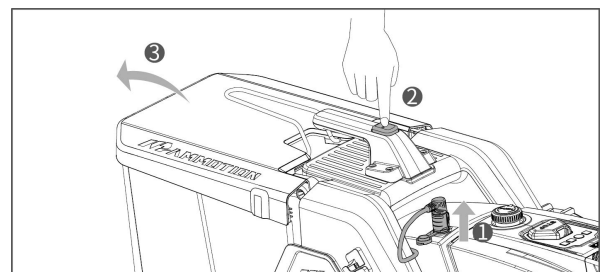

4 Operation



NOTE

The screens are for reference only. Please refer to actual user interfaces.

4.1 Preparation



- Read and understand safety instructions before operation.
- The charging station and RTK reference station have been properly installed.
- Ensure the robot has already docked on the charging station.
- Ensure there is a stable network and keep your phone Bluetooth on.

4.2 Download Mammotion App

The robot is designed to work with the Mammotion app, please download the free Mammotion app first. You can scan the QR code below to get it from the Android or Apple app stores, or search for Mammotion in these stores.



After installing the app, please sign up and log in. During use, the app may ask you for Bluetooth, Location, and local network access when necessary. For optimal use, it is recommended to allow the above access. For more information, please refer to our Privacy Agreement. Go to Mammotion app > **Me** > **About Mammotion** > **Privacy Agreement**.

If you want to log in with a third-party account, tap  or  on the login page to continue. Mammotion app now supports logging in with Google and Apple accounts.

4.3 Add Your Product

NOTE



- Make sure the distance between your phone and the device is less than 3 m (10 ft.).
 - You can skip the Wi-Fi setup if you are using 4G cellular data. It is advisable to also establish a connection to a Wi-Fi network for optimal performance.
-

4.3.1 Add Devices

1. Tap **+** to add your robot or RTK reference station.
2. Select **Add**.
3. Follow the onscreen guidelines to set up the device.
4. Follow the onscreen instructions to connect the device and set network successfully.
5. Follow the onscreen instructions to activate the built-in SIM card.

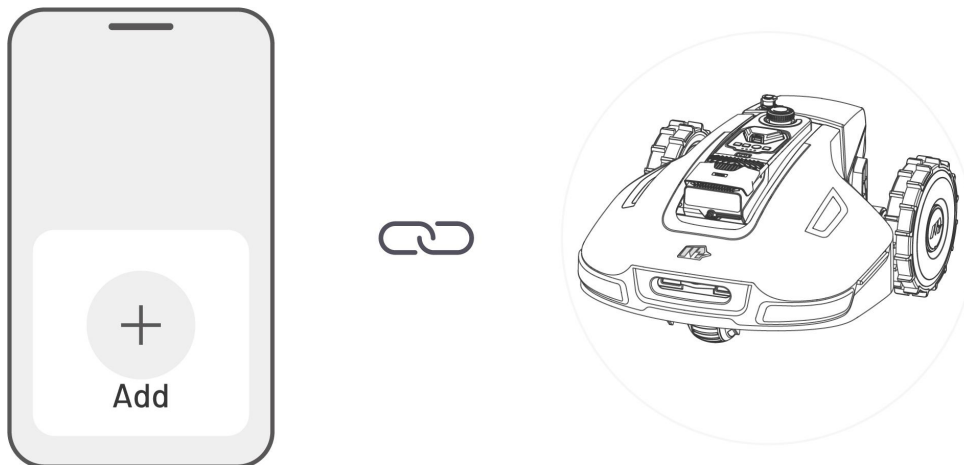

4.3.2 Add New RTK Reference Station after Replacing

If your RTK reference station is replaced, please follow the below steps to add the new one.

1. Tap **Settings** > **Positioning Mode** > **Antenna over Datalink**.



2. Enter the new LoRa number. The LoRa number is indicated on the nameplate of the RTK reference station. Tap **OK** to proceed.
3. Verify that the LoRa number matches the one on the nameplate and the RTK Connection shows 'Connected'. Your setup is now successful.

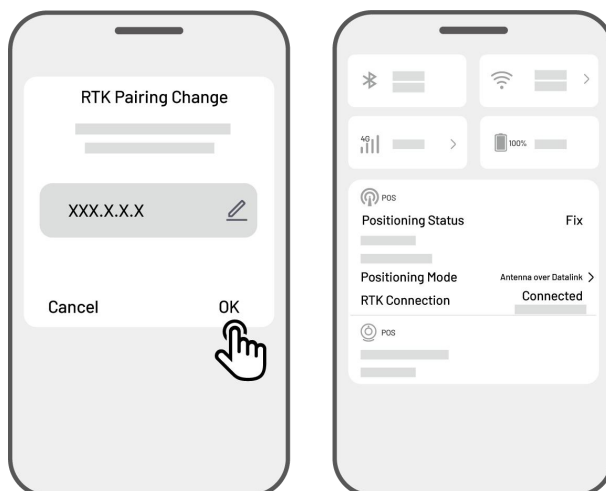

NOTE



Replacing the RTK reference station will require you to remap your lawn if a map has been created.

4.4 Activate SIM Card

If you didn't activate the SIM card during the device binding process, you can do so by tapping the Status Bar on the Home page:

1. Tap the **Status Bar** on the Home page.
2. Tap the **4G status** button.
3. Tap **Activate** and wait for the activation to complete successfully.



4.5 Update Firmware

For optimal experience, ensure your devices are updated to the latest firmware version.

➤ To update the firmware

1. Go to **Settings > Device information > Robot version** to update the firmware.
2. Ensure the robot is connected to a stable network.

During the update, please avoid exiting the app, performing other operations, or turning off the robot.



4.6 Create a Map

4.6.1 Map out the Task Area

Preparation

Before mapping, it is important to be aware of key considerations.

- Remove debris, piles of leaves, toys, wires, stones, and other obstacles from the lawn. Make sure no children or animals are on the lawn.

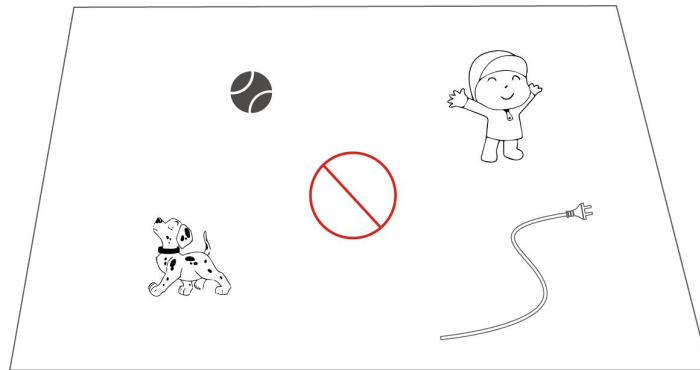

Map your Lawn

1. Make sure the robot is powered on and your phone Bluetooth is on. Your phone will connect to the robot automatically with a Bluetooth connection.

2. Tap **Create a Map** to start.

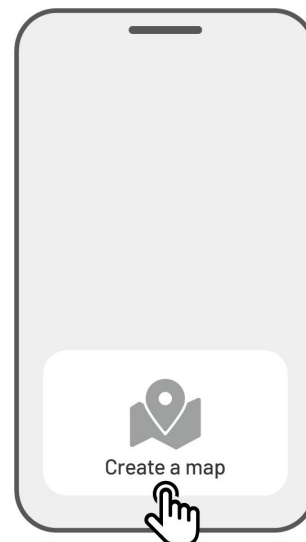

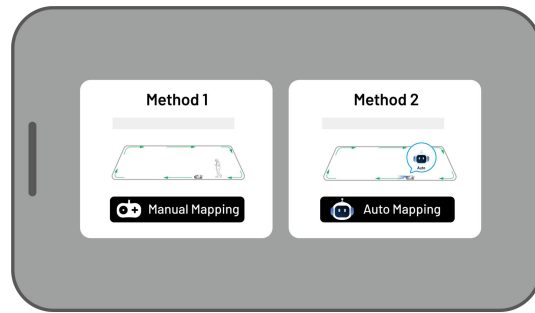

3. Select **Manual Mapping** or **Auto Mapping** to continue.



Manual Mapping

1. Control the robot to a proper starting point of the perimeter and tap  to start mapping.

- Move the virtual joystick  up or down to control the robot's forward or backward movement.
- Move the virtual joystick  left or right to turn the robot left or right.

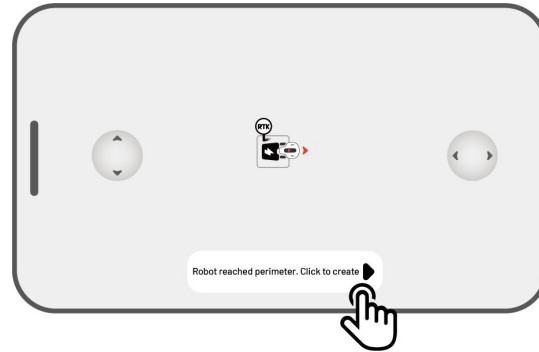

2. Guide the robot along the perimeter. Keep the controller 1.5 meters (4.9 feet) of the robot to maintain a stable Bluetooth connection.

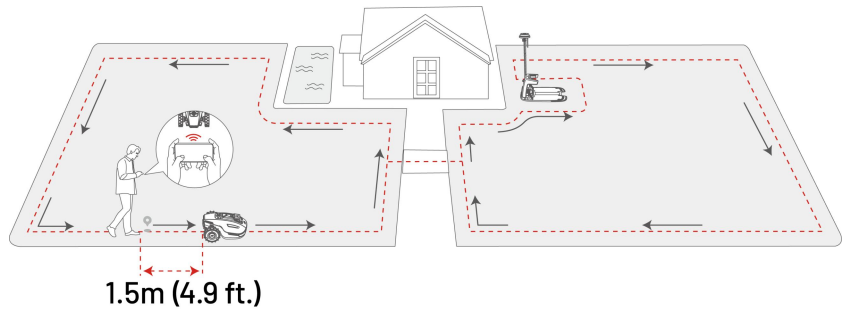

- a) If the perimeter meets an obstacle such as a wall, fence, ditch, or uneven pathway, maintain a distance of at least 15 cm (6 in) from the perimeter while guiding the robot.

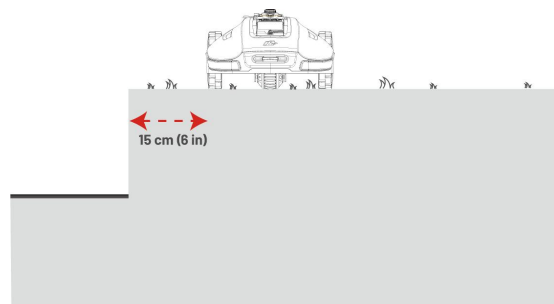

b) If the perimeter meets a level, even pathway, it is recommended to guide the robot on the pathway for more efficient cutting.

3. Tap **Discard and Exit** to clear all unsaved data and remap during the mapping process if needed.

4. Control the robot back to the starting point and tap **Save** to finish mapping.

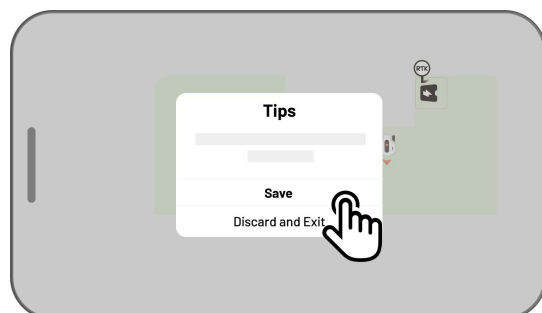
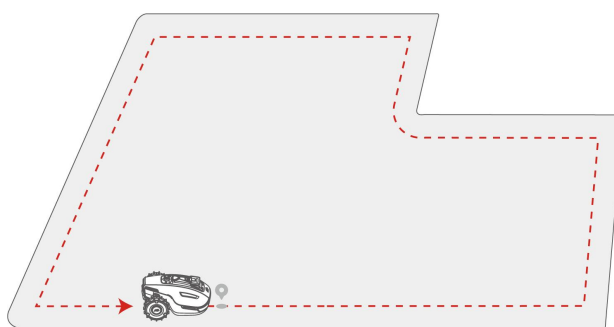
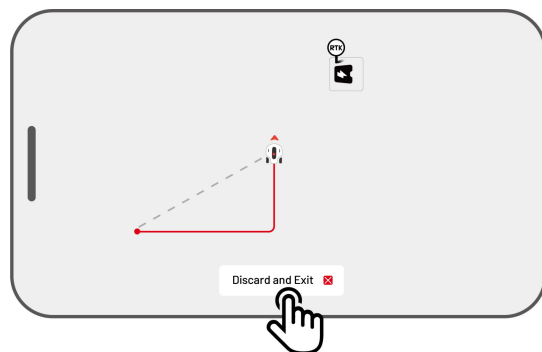
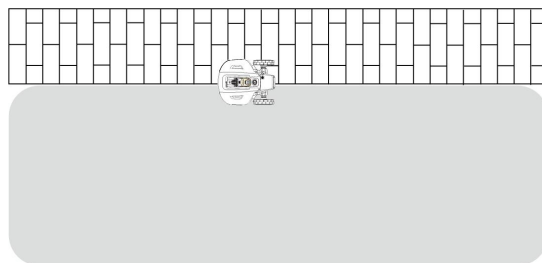

Auto Mapping

NOTE



- Remove any obstacles before starting auto mapping.
 - Keep your phone active and do not switch to other apps.
 - Follow the robot during the mapping process.
 - Ensure the Bluetooth connection between the robot and your phone remains uninterrupted.
 - Please do not use Auto Mapping in scenes with steps, cliffs, ponds, or similar obstacles.
-

The Auto Mapping feature uses the robot's vision camera to detect the physical perimeter of the lawn. When the camera identifies a clear perimeter, Auto Mapping is activated, allowing the robot to autonomously map the lawn's perimeters.

Tap **Auto Mapping** to initiate this feature.

If the robot malfunctions, tap the **Stop** button and then manually control it to continue mapping.

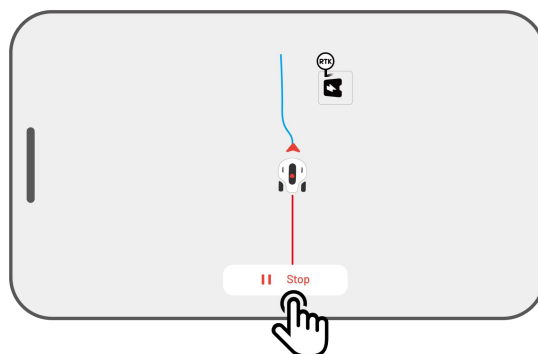
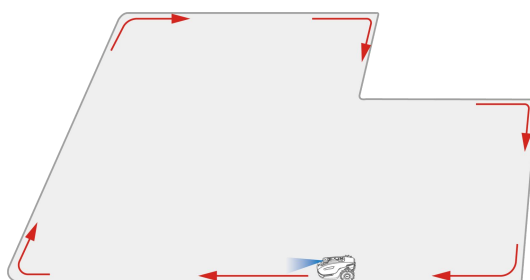

NOTE





- When mapping, the system will estimate the area. Please ensure that the area is not more than the upper limit (See **Technical Specifications** for more information), or the task area mapping will fail.
 - Drive the robot out of the task area or no-go zone first if a new area is created.
-

4.6.2 Map out a No-go Zone

No-go zones are created for pools, flowerbeds, trees, roots, ditches, and any other obstructions present in the lawn. The robot will avoid mowing inside these designated areas.

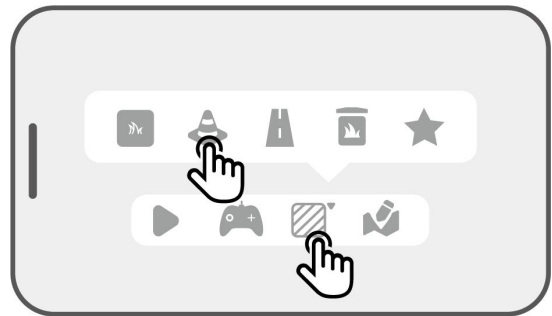
1. Tap **Create > No-go zone** on the Map page.



2. Guide the robot around the perimeter of a no-go zone, then tap  to start mapping.

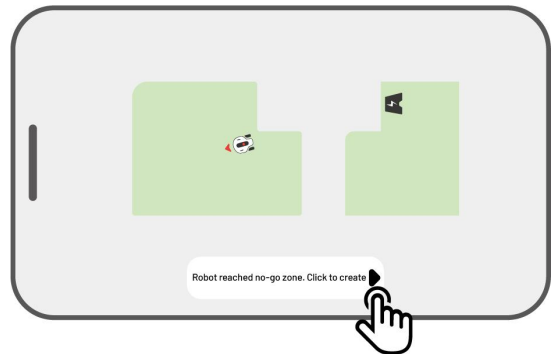

3. Control the robot along the perimeter of the no-go zone and back to the start point to complete mapping the no-go zone.

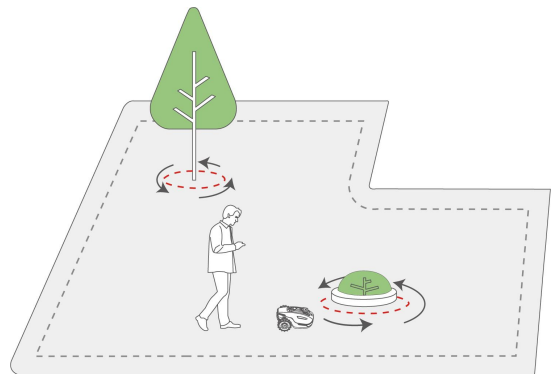

4. Tap **Save** to finish the setting.

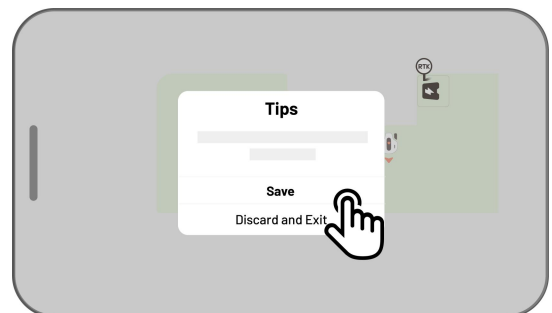

4.6.3 Map out a Channel

The channel is intended to connect various task areas or link the task area with the charging station.

1. Tap **Create** > **Channel** on the map page.

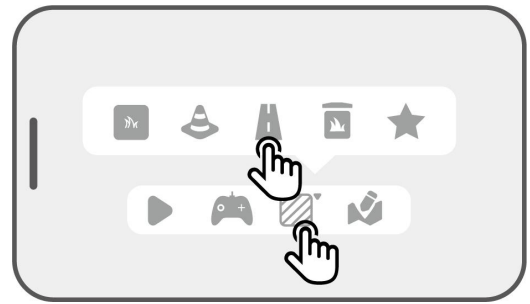

2. Control the robot into a task area. Tap  to start mapping.

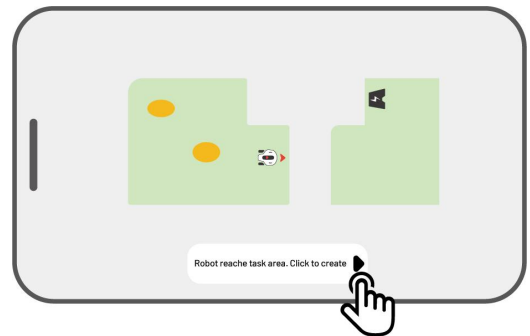

3. Manually control the robot from a task area to another task area or to the charging station.

NOTE



- The channel should be wider than 1 m (3.3 feet).
- The channel should be free from significant bumps.

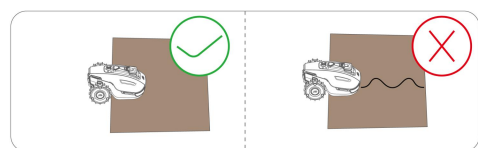
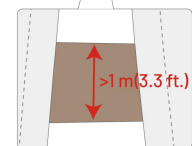
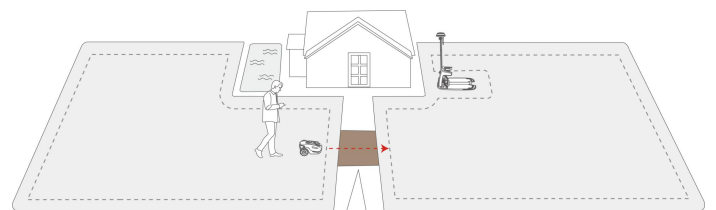

4. Tap **Save** to finish the setting.

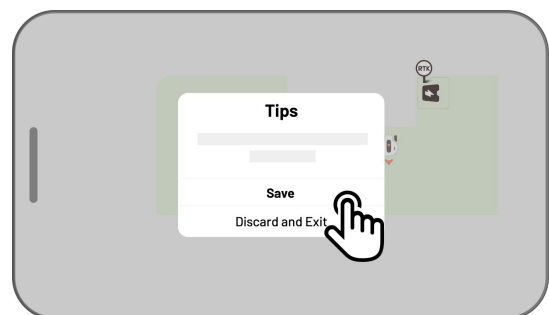

4.6.4 Mark a Dumping Spot (Optional)

After the self-emptying lawn sweeping kit is successfully installed, you are ready to set it up in the Mammotion app.

A dumping spot is where the robot sends collected grass clippings, leaves, and debris. Once a task area is created, you can define the dumping spot either inside or outside the task area.

1. Tap **Create > Dumping spot** on the Map page.

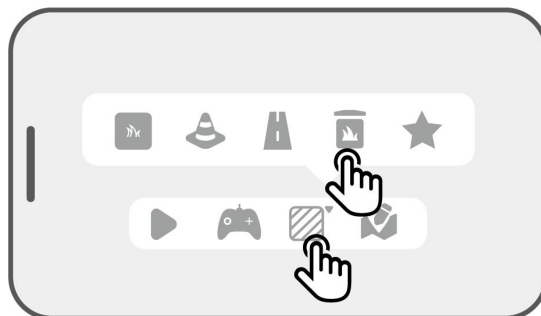

2. Control the robot into a task area or near a perimeter, then tap ▶ to start.

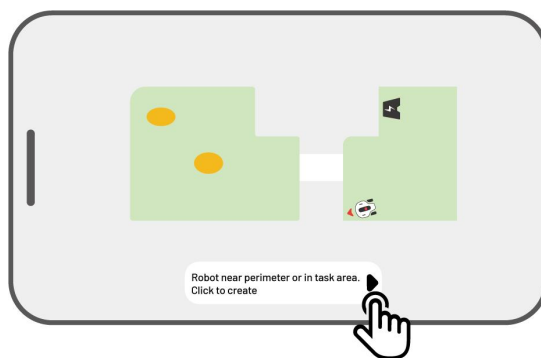

3. Manually drive the robot to the designated spot, then tap  to mark this spot as the dumping area. You can set multiple dumping spots.

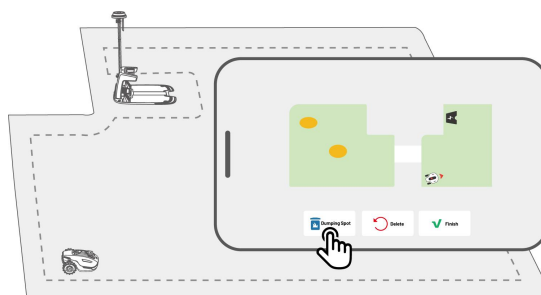

4. Tap **Finish** to save the setting.

5. Drive the robot back to the task area and tap **Finish** to finalize the mapping process if the dumping spot is located outside the task area.

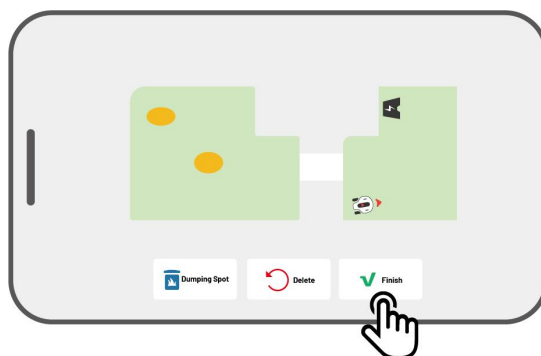

NOTE

- Ensure that there are no objects within a 2-meter diameter of the dumping spot.
 - The distance between two dumping spots should not be less than 1 m (3 feet).
 - If the dumping area is located outside the task area, a channel will be created automatically while manually driving YUKA back to the task area.
-

4.6.5 Create a Pattern

The pattern is designed to personalize your lawn-cutting experience, and after it's added, the grass on the patterned area will be preserved while cutting to maintain its design. See the available patterns in the app.

1. Tap **Create > Pattern** on the Map page.

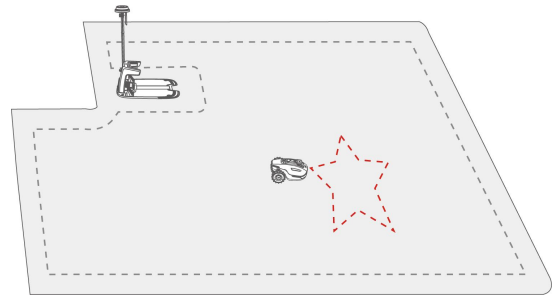

2. Choose the pattern that you want to create.



3. Drag and zoom in/out the pattern to adjust its location and size.

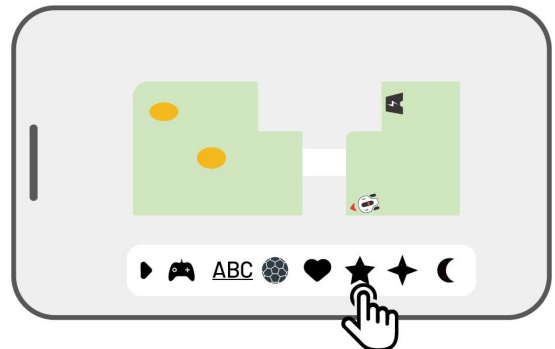

4. Tap **Finish** to finish the setup.

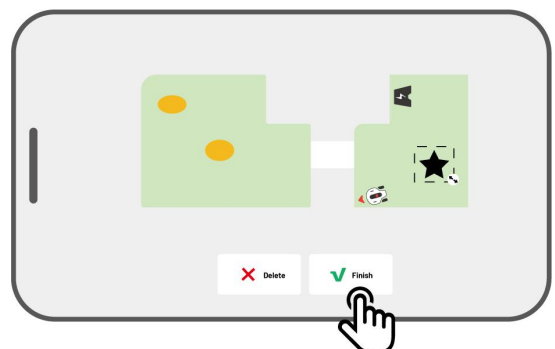
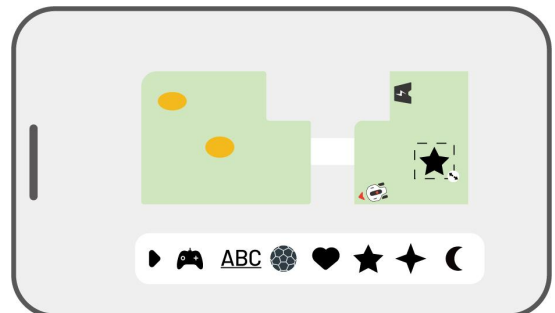

NOTE



- Each task area can have a maximum of 10 patterns, with a total limit of 50 patterns overall.
 - The pattern should not be placed too close to the task area perimeter, no-go zone, or charging station. Maintain a minimum distance equal to the width of the robot.
-

Edit the Pattern

After creating a pattern, you can choose to enable or disable it at any time. When enabled, the grass in the patterned area will be preserved during mowing to maintain its design, or mowed when disabled. Tap

Edit > ●●● to open the pop-up.

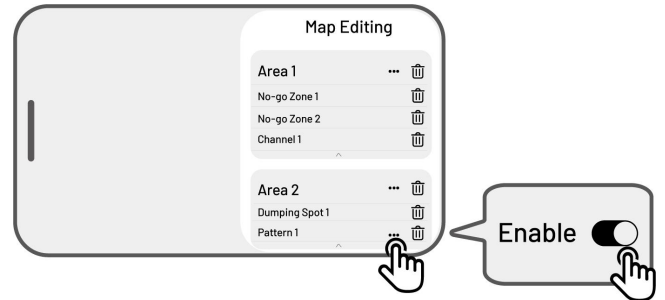

4.6.6 Edit Your Map

Rename the area

Mammotion allows you to create multiple areas. For easy management, you can rename the area.

1. Tap **Edit** > ●●● to open the popup.

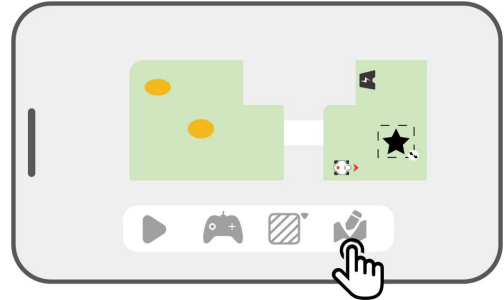

2. Tap **Rename** to set a name for the area.

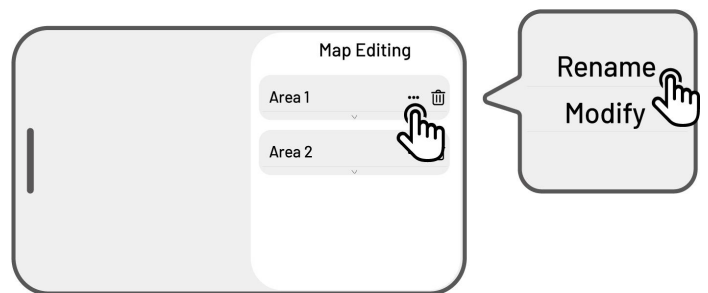

4.6.7 Modify the Area

If changes occur in your lawn after mapping, such as planting a tree near the perimeter, the appearance of a hole, or weak positioning signals, you can adjust the mapped area without needing to delete it entirely.

1. Tap **Edit** > ●●● to open the popup.

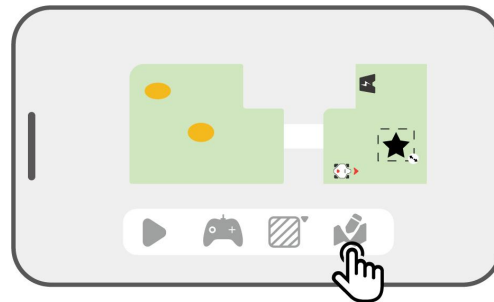

2. Tap **Modify** to re-draw the perimeter.

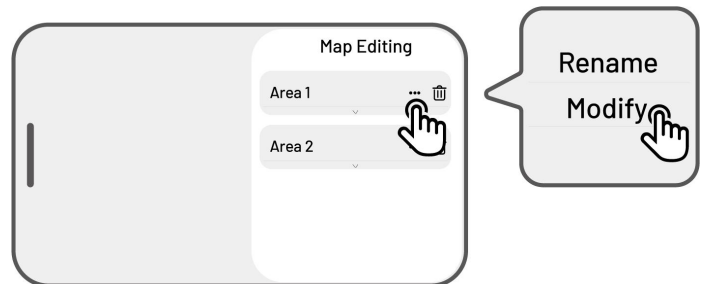

Delete the area/no-go zone/channel/dumping spot

To delete an area, no-go zone, channel, dumping spot, or pattern, tap **Edit** > 🗑️. Deleting an area will also remove all items within it.

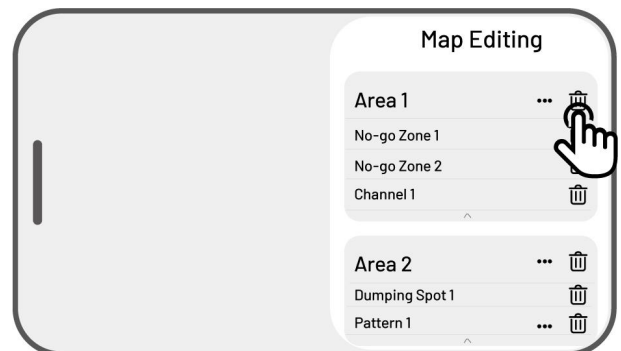

4.6.8 Multiple Task Areas with Overlapping

If you have several lawns that overlap, the shared section will be assigned to the task area that was created first. No channel is necessary for two task areas with overlapping sections.

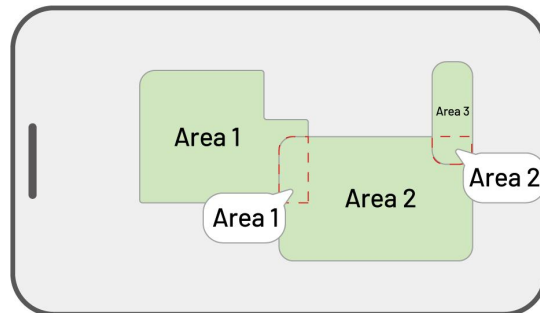

4.6.9 What to Do If RTK Reference Station is Moved after Mapping

Do not move the RTK reference station after the map is created or the resulting task area will diverge from the designated task area.

In the event of an RTK reference station relocation, reinstall it in its original position, or go to **Settings**  > **Robot settings** > **Delete map** to delete the current map and remap the area.

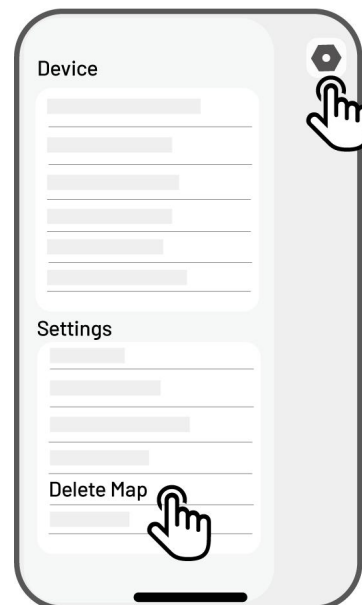

4.7 Mow and Sweep

4.7.1 Preparation

- If any unexpected problems arise, please press the **STOP** button and secure the robot. The STOP button holds top priority among all commands.
- If the lift sensor is activated, the robot will come to a halt. Please press the **Grass** button followed by the **START** button to unlock it.
- Please mow the task area no more than once a day as doing so may be harmful to your lawn.
- The robot supports a maximum grass height of 130 mm (5 in) for the US version and 120 mm (4.7 in) for other versions. It is recommended to adjust the cutting height according to the grass height for each mowing as follows. **Adjust the cutting height by manually pressing down and turning the Cutting Height Adjustment Knob  on the robot before mowing.**

Grass Height	Cutting Height
100-130 mm (3.9-5 in)	Set to 100 mm (3.9 in)
100-120 mm (3.9-4.7 in)	Set to 90 mm (3.5 in)
60-100 mm (2.4-4 in)	Cut by 20 mm (0.8 in)
20-60 mm (0.8-2.4 in)	Cut by 10 mm (0.4 in)

- Ensure the robot is at the charging station or within the task area before mowing. If not, manually move or guide the robot to the charging station or task area.

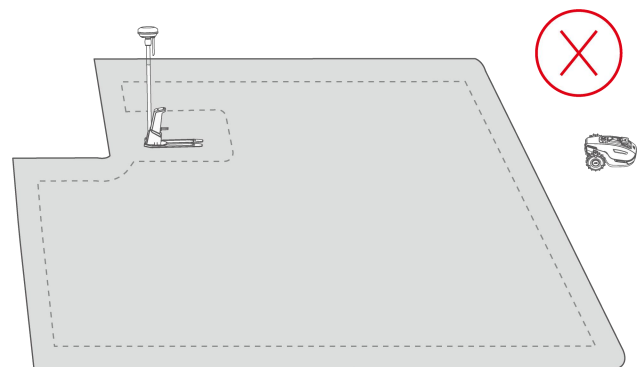
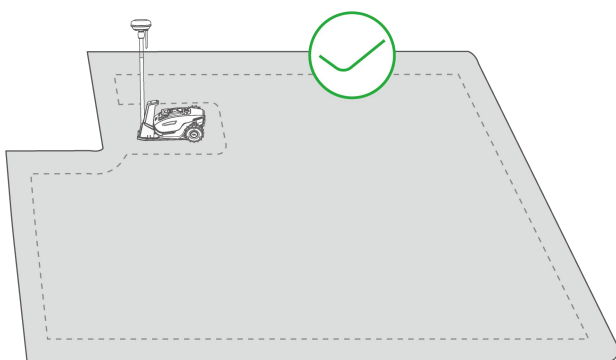

- Ensure a channel is created between task areas or between a task area and the charging station. Without it, the robot will not be able to automatically return for charging when the battery is low.

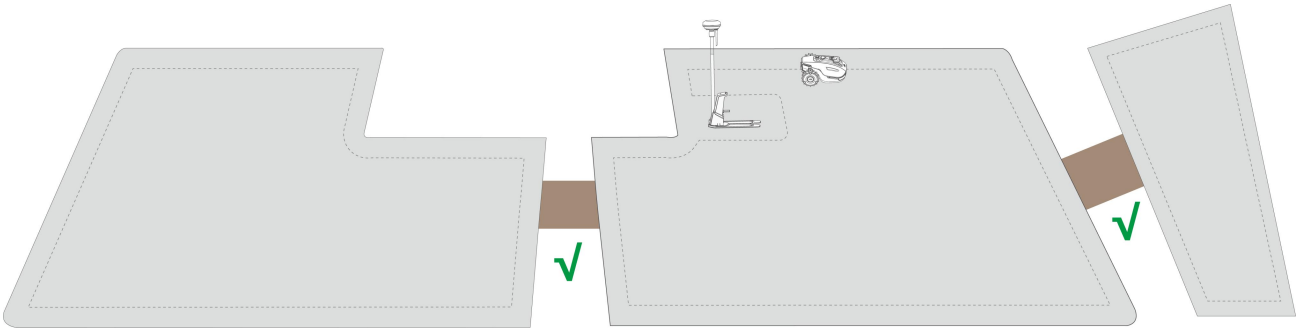

4.7.2 Start Working

If you prefer not to set parameters, simply tap  on the Home page to quickly start mowing. The robot will mow only in this mode.

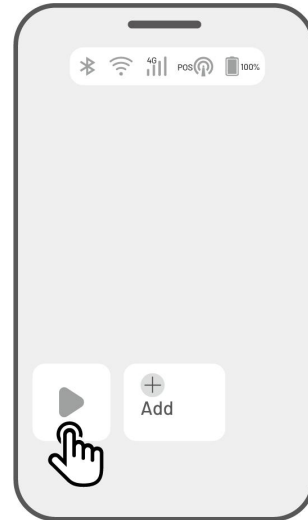

If you prefer to customize settings before working:

1. Tap the robot image to enter the Map page.
2. Tap **Mow**  to access the task page.
3. Configure the parameters and tap **Start** to commence working.

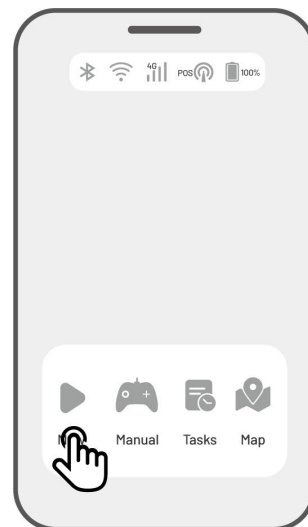

Task settings



IMPORTANT

The Sweep function is available only on robots equipped with a sweeper kit.

Tap **Mow** to access the task parameters.

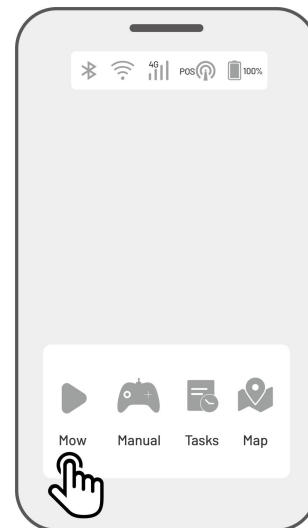

Mow Only

1. Tap **Mow** on the Task page.
2. Select the area that you want to mow.
3. Tap  to configure the parameters.
4. Tap **Save** to apply the settings.
5. Tap **Start** to commence mowing, or tap **Save** to create a task schedule.

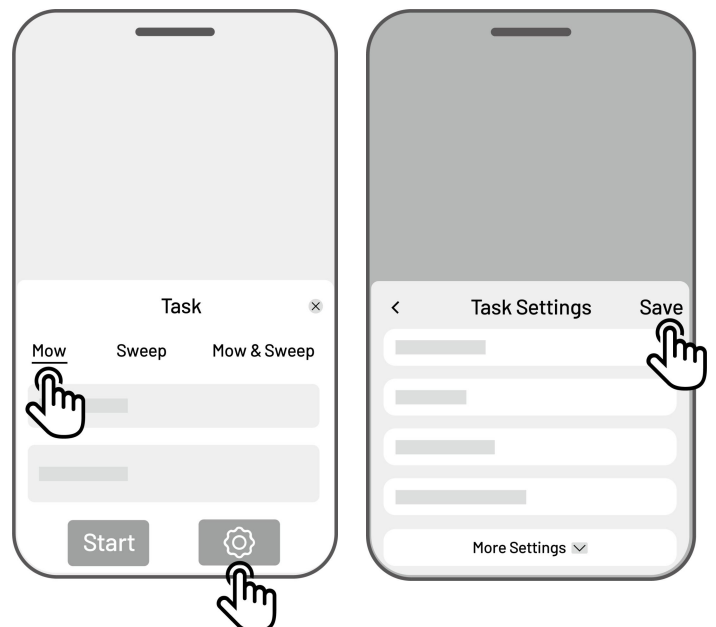

Sweep only

1. Tap **Sweep** on the Task page.
2. Select the area that you want to sweep.
3. Tap  to configure the parameters.
4. Tap **Save** to apply the settings.
5. Tap **Start** to commence sweeping, or tap **Save** to create a task schedule.



Mow and Sweep

1. Tap **Mow & Sweep** on the Task page.
2. Select the area that you want to maintain.
3. Tap  to configure the parameters.
4. Tap **Save** to apply the settings.
5. Tap **Start** to commence working, or tap **Save** to create a task schedule.



Other parameters

- **Frequency**

You can set the working frequency here.

- ✧ **Now** – The robot will commence work promptly upon configuration.
- ✧ **Weekly** – The robot will repeat the task every week based on your preferences.
- ✧ **Periodicity** – specify non-working days. For example, if you input 3 days, the robot will operate once every 4 days as per your settings.

- **Dumping interval**

The robot will dump once based on the settings.



IMPORTANT

The Dump function is available only on robots equipped with a sweeper kit.

- **Task speed**

You can adjust the working speed of the robot here.

- **Cutting path angle (°)**

- ✧ **Optimal**

Take the most efficient path recommended by the algorithm as the 0-degree direction.

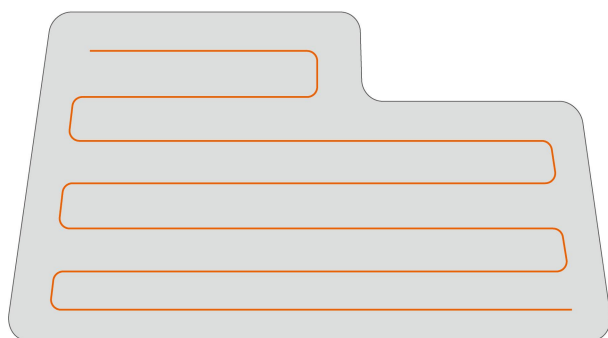

Before setting

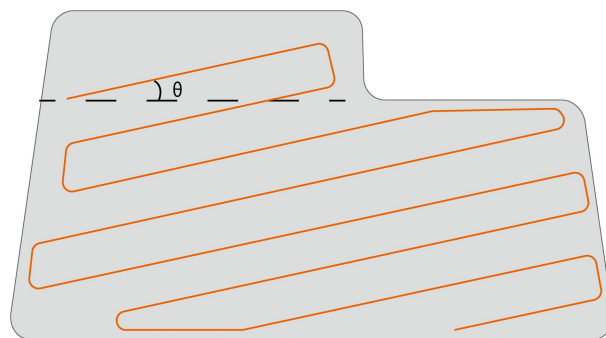

After setting

- ✧ **Random**

The working direction will change each time the robot starts a new task.

- ✧ **Customize**

The adjustment angle range is 0 to 180°.

- **Cutting path mode**

1. **Zigzag path**

The robot will mow in straight and single rows.

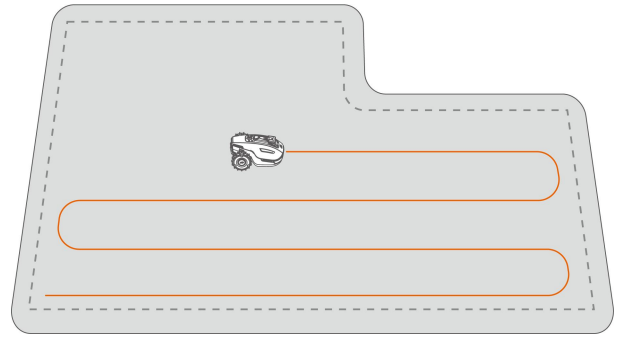

2. **Chess board path**

The robot will work in straight rows both horizontally and vertically.

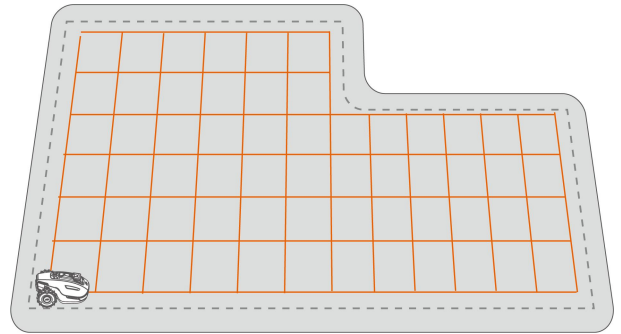

- **Perimeter mowing**

When enabled, the robot will work along the perimeter. When disabled, the robot will avoid working at the perimeter.

- **No-go zone perimeter mowing**

The robot will mow the no-go zone perimeters two circles when enabled.

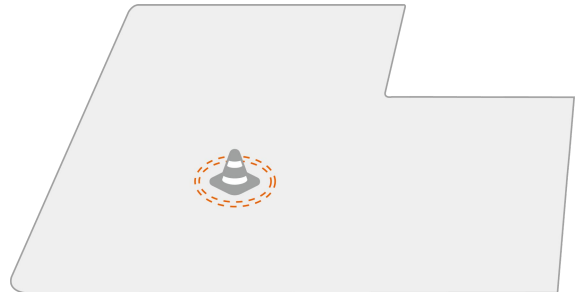

- **Start progress**

The robot will start working from the set percentage.

- **Obstacle avoidance**

- ◇ **Off**

The robot will attempt to reach every spot of the selected areas. When encountering an obstacle, it will gently bump into it and then navigate around, ensuring a cleaner trim along walls and obstacles.

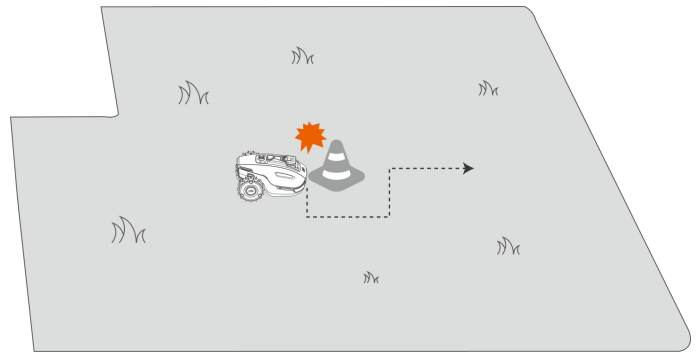

- ◇ **Standard**

The robot will proactively avoid obstacles to prevent collisions, which reduces damage and improves efficiency.

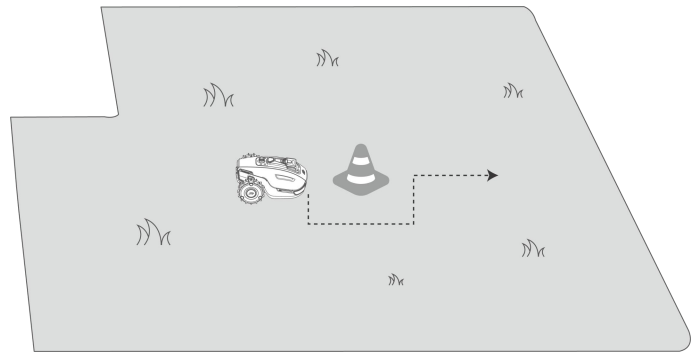

- ◇ **Sensitive**

The robot will proactively avoid obstacles and non-grassy areas, reducing the risk of falling or leaving the lawn. However, some dried-out patches may be missed and could also block the returning path.

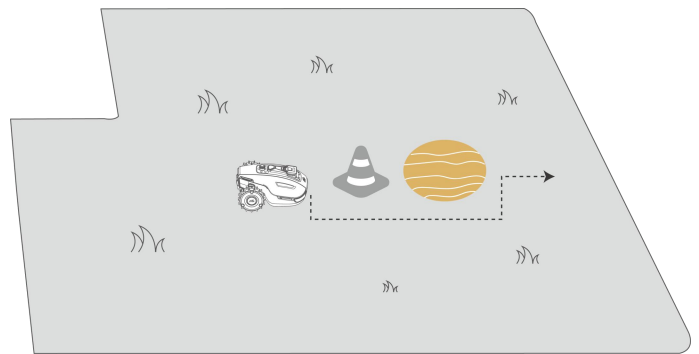

When the robot enters an area where RTK signals are weak while mowing

If the robot enters an area where RTK signals are weak while mowing, the multi-sensor fusion positioning system will assist it in continuing to operate through the vision module. The vision navigation can last for 300 meters (984 feet) The robot should return to an area covered by RTK signals before the vision navigation reaches its limit, otherwise, it will come to a stop.

4.8 Task Schedule

With the Schedule function, you can set a regular task and YUKA will automatically do its work according to your setting.

4.8.1 Set a Schedule

1. Tap **Add** on the Home page or tap **Tasks** on the Map page to enter the Task page.
2. Select the area that you want to mow.
3. Tap  to configure the parameters.
4. Tap **Save** to apply the settings.
5. Tap **Start** to commence working, or tap **Save** to create a task schedule.

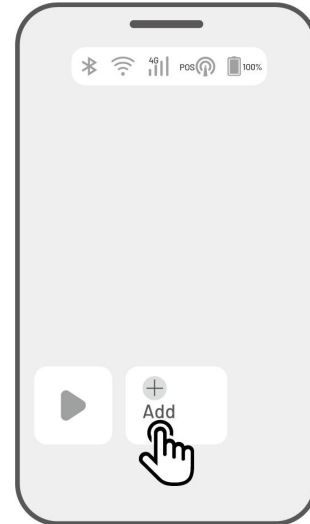



NOTE



- The task schedule adding is temporarily disabled when the robot is working.
 - A schedule can be set after a task area has been created.
 - See ***Other parameters*** for detailed information on parameters.
-

4.8.2 Edit a Schedule

Tap Tasks on the Map page to access the schedule list. Tap **⋮** on the schedule you set to open the drop-down menu.

- **Enable** – toggle the button  to off  to inactivate the schedule if needed.
- **Rename** – tap to change the name of the schedule.
- **Edit** – tap to change the schedule.
- **Run now** – tap to run this schedule immediately.
- **Copy** – tap to create a new schedule with the same settings while keeping the original schedule, then choose one to edit.
- **Delete** – tap to delete the schedule.

If the exclamation mark  appears, it indicates that the task schedule cannot be performed due to errors. Tap the exclamation mark for more details.

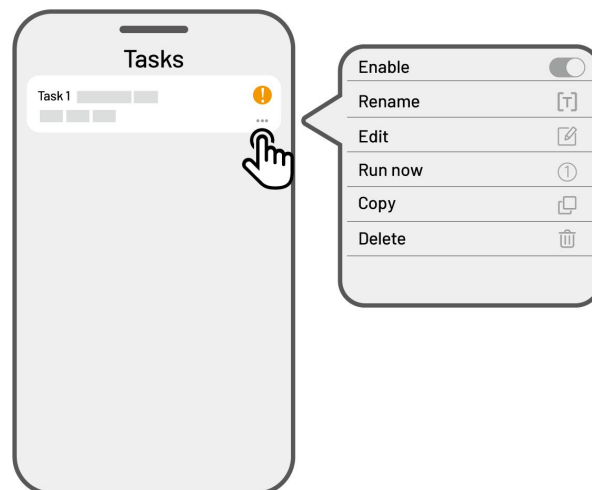

4.9 Manual Operation

4.9.1 Manual Mowing

If you prefer to mow your lawn manually, the Manual Mowing feature is available for your use.

To ensure your safety, please use the **Manual Mowing** function with care and observe the following:

- Minors are not permitted to use this function;
- Please always supervise your children, pets, and important belongings to prevent accidents;
- Take extra care when using the manual lawn mower function to avoid injury.

Activate Manual Mowing

1. Tap the robot image to enter the Map page.
2. On the Map page, select **Manual**.
3. Tap **Manual mowing**, then drag the button to the right to start the cutting disc.
4. Maneuver forwards/backward or turn left/right to start working.

NOTE



- The cutting disc will automatically stop after 5 seconds of inactivity.
 - Drag to the right as prompted by the app to start the cutting disc after each stop.
-

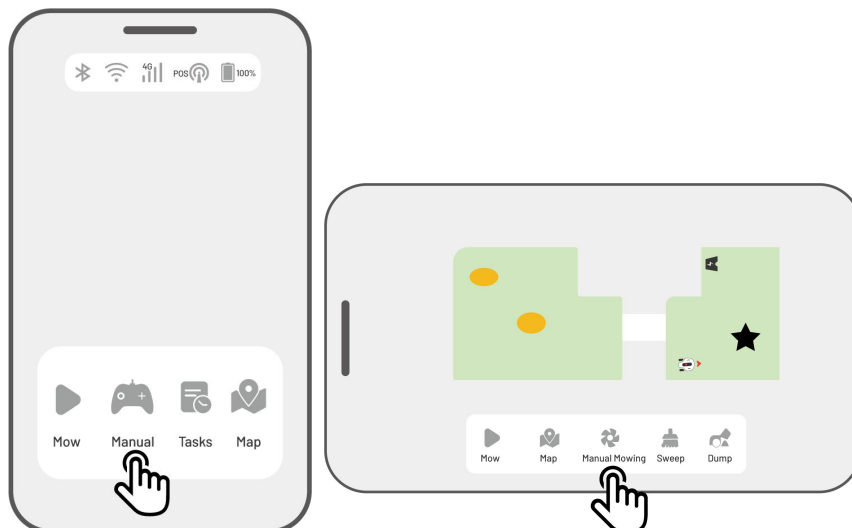

4.9.2 Manual Sweeping and Dumping



IMPORTANT

The Manual Sweeping and Manual Dumping functions are available only on robots equipped with a sweeper kit.

Activate Manual Sweeping

1. Tap the robot image to enter the Map page.
2. On the Map page, select **Manual**.
3. Tap **Sweep**, then maneuver the robot forwards/backwards or turn left/right to start working.
4. Guide the robot to the Dumping spot and tap **Dump** to unload the collected grass clippings, leaves, and debris.

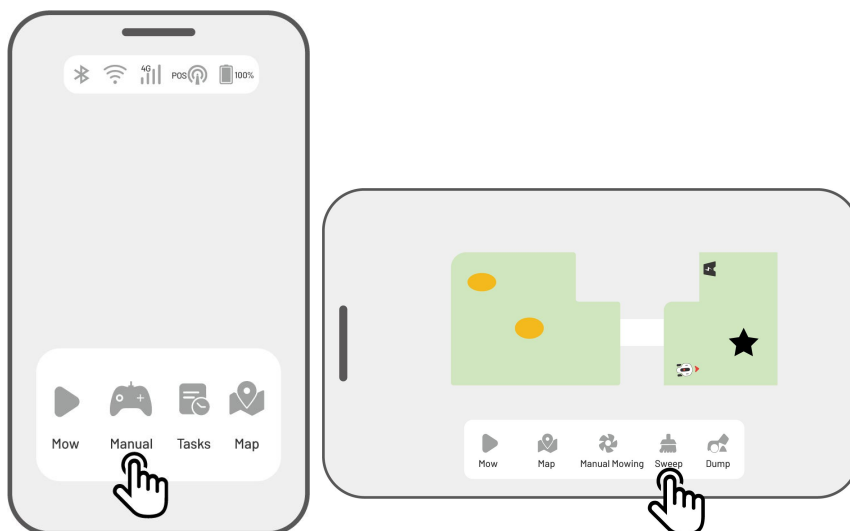

4.9.3 Activate FPV Mode

FPV Mode (First-Person View Mode) provides an immersive way to control and monitor your robot. By activating this mode, the robot's onboard camera streams live video, allowing you to see directly from the robot's perspective for enhanced control and navigation.

Additionally, FPV mode can turn your robot into a mobile security camera, providing real-time video surveillance and enabling you to monitor various locations remotely from the robot's viewpoint.

- When the robot is working, tap the **FPV icon** on the working page.

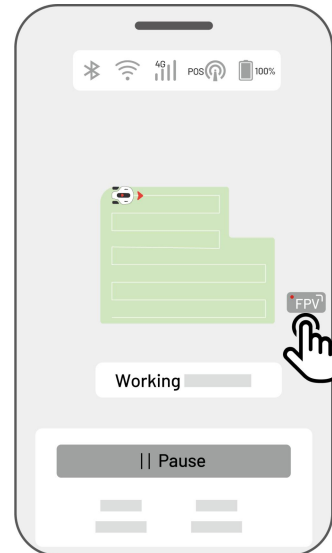

- On the Manual Operation page, tap the **FPV icon**.

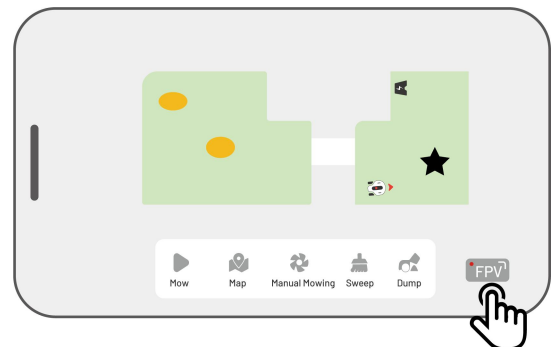



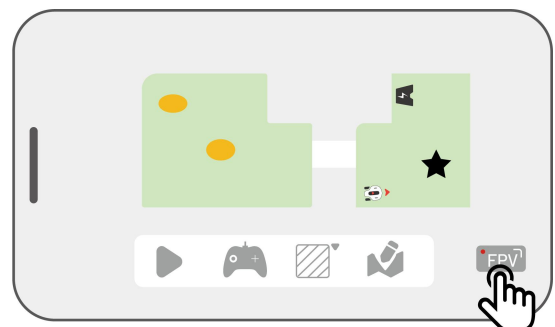



- On the Landscape Map page, tap the **FPV icon**.

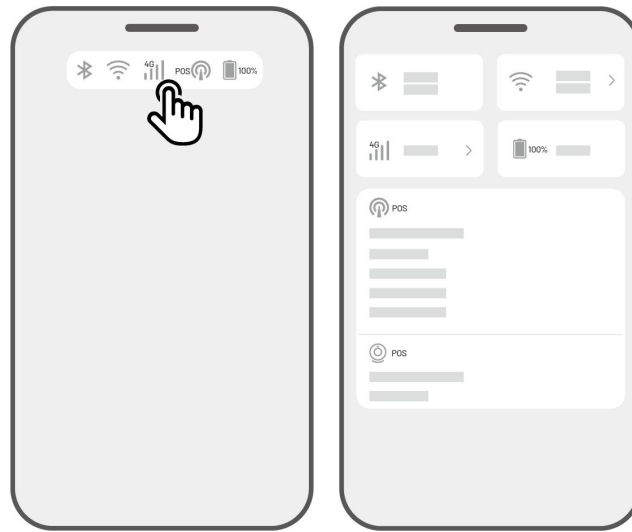

4.10 View Status

Tap the **Status Bar** to view the device status.



Icon	Name	Description
	Bluetooth	Indicates the Bluetooth signal.
	Wi-Fi Connectivity	Indicates the connected Wi-Fi signal strength.
	4G Connectivity	Indicates the cellular signal strength.
	Battery Level	Indicates the remaining battery level.
	Positioning	Indicates the positioning status.
	Vision Module Status	Indicates the vision module status.

- **Positioning status** – shows the strength of satellite positioning.
 - ✧ **Fix** – fine positioning status with an accuracy of less than 10 cm/4 in, up to 2 cm/1 in with a good open-sky area.
 - ✧ **Float** – poor positioning status with an accuracy of about 50-200 cm/20-79 in.
 - ✧ **Single** – bad positioning status with a meter-level accuracy.
 - ✧ **None** – no positioning status.

*Only Fix status enables automatic mowing.

- **Satellites** – refers to the total number of satellites received by the robot and RTK reference station.
 - ✧ **R** stands for the number of satellites received by the robot.
 - ✧ **B** stands for the number of satellites received by RTK reference station.
 - ✧ **C** stands for the number of co-viewing satellites received by both the robot and RTK reference station.
 - ✧ **L1** and **L2** respectively indicate the satellites operating at L1 and L2 frequencies.
- **Signal quality**
 - ✧ **R** stands for satellite signal strength of the robot.
 - ✧ **B** stands for satellite signal strength of RTK reference station.

*The accuracy of positioning is affected by the quality of the satellite signal and the number of Co-Viewing satellites. Objects such as trees, leaves, walls, and fences can weaken the signal and lead to positioning errors. Despite the detection of more than 20 satellites by both the robot and RTK reference station, the signal quality can still be deemed as Weak or Bad.
- **Positioning mode** – shows positioning details.
- **RTK connection** – indicates the connection status of RTK reference station.
- **Vision positioning status** – shows the strength of vision positioning.
 - ✧ **Fine** – vision positioning is optimal.
 - ✧ **Bad** – vision positioning is poor.
 - ✧ **Initialization** – vision module is initializing.
 - ✧ **None** – no vision positioning available.
- **Brightness** – shows the strength of ambient light.
 - ✧ **Fine** – ample brightness for vision positioning.
 - ✧ **Dark** – insufficient brightness; vision positioning cannot operate.

4.10.1 Switch Positioning Mode

NetRTK

The NetRTK feature allows the robot to operate without the need for an RTK reference station. This feature enhances flexibility and reduces setup complexity, making it easier to deploy the robot in a wider range of locations.

NOTE



- The NetRTK feature is currently unavailable in some regions. Please contact our after-sales support for more information.
- Ensure the 4G network or Wi-Fi network is strong and stable for optimal performance.

Enable NetRTK

1. Tap the **Status Bar** to access the status information page.

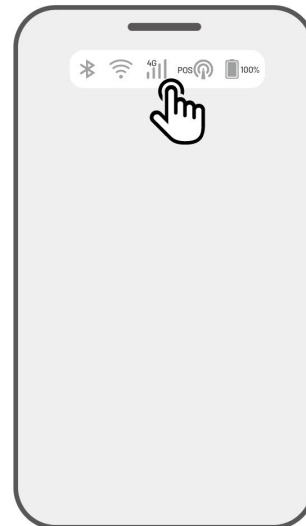

2. Tap **Positioning Mode**.

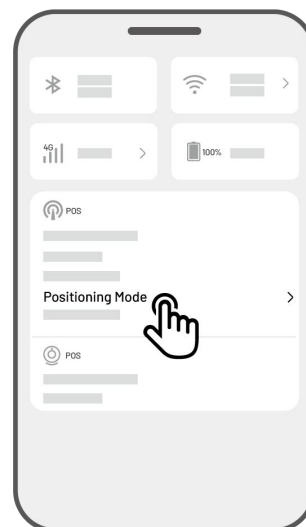

3. Select **NetRTK**.

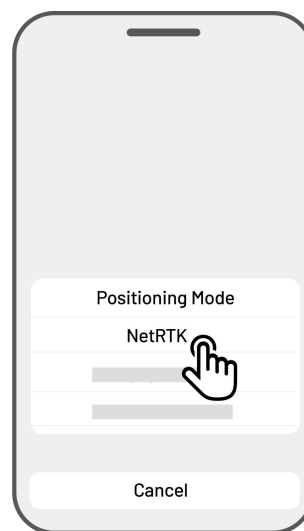

4. Return to the status information page and verify that the positioning mode displays '**NetRTK**', the RTK positioning status shows '**Fix**', and the RTK connection status shows '**Connected**'. Your setup is now complete.

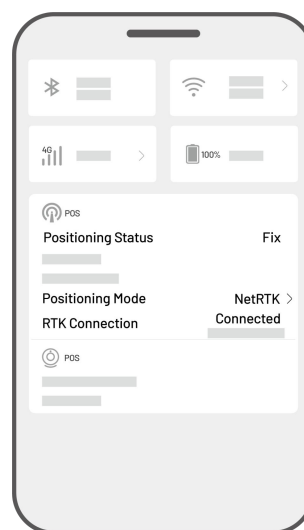

Antenna over Internet

Antenna over Internet utilizes the internet for data communication between the RTK reference station and the robot. It significantly expands the range of RTK applications, enabling operation over large geographical areas.

IMPORTANT



- Antenna over Internet relies on a stable 4G network. It is crucial to ensure that the robot maintains a reliable 4G connection.
- Please ensure that both the robot and RTK reference station are bound to the same account.
- For optimal operation, it is recommended to update both the robot and RTK reference station firmware to the latest versions.

Enable Antenna over Internet

1. Verify the 4G icon on the Status bar to illuminate, indicating successful activation of the SIM card. Tap the **Status Bar** to access the status information page.

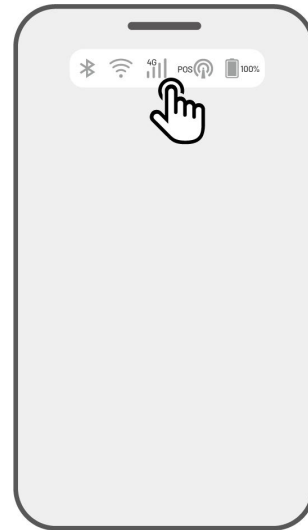

2. Tap **Positioning Mode**.

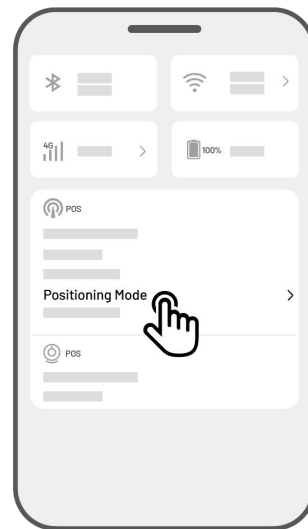

3. Select **Antenna over Internet** and tap the RTK reference station to configure your network.

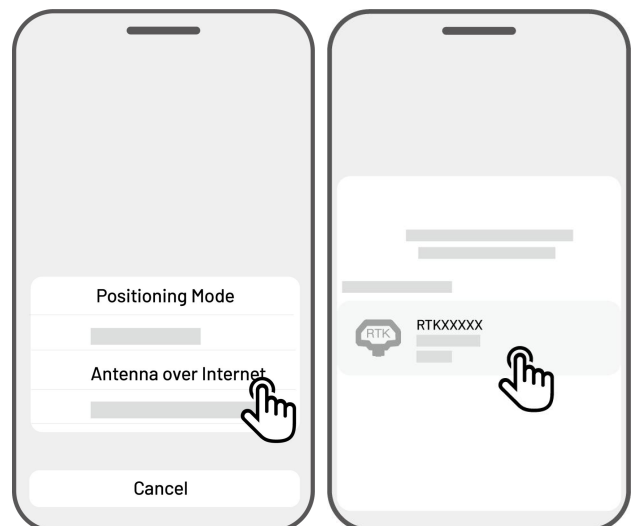

4. Wait for a green check mark to appear, then return to the status information page. Verify that the RTK positioning status displays '**Fix**' and the RTK connection shows '**Connected**'. Your setup is now complete.

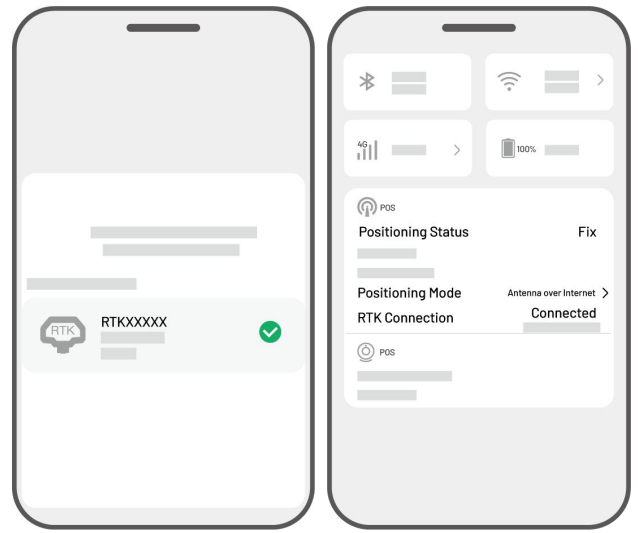

Antenna over Datalink

Antenna over Datalink involves data communication between the RTK reference station and the robot using radio antennas.

Enable Antenna over Datalink

1. Tap the **Status Bar** to access the status information page.

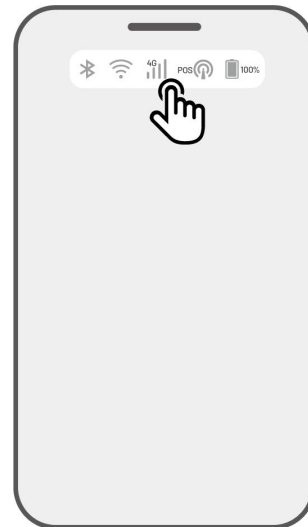

2. Tap **Positioning Mode**.

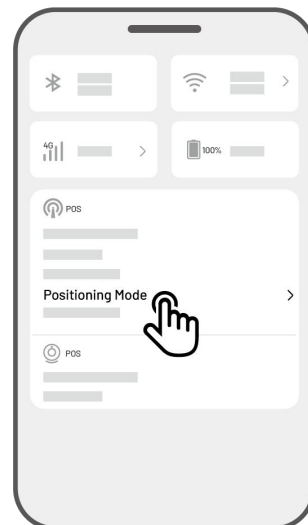

3. Select **Antenna over Datalink**, and ensure the displayed LoRa number matches the one on the RTK reference station's nameplate. If not, input the correct one. Tap **OK** to proceed.

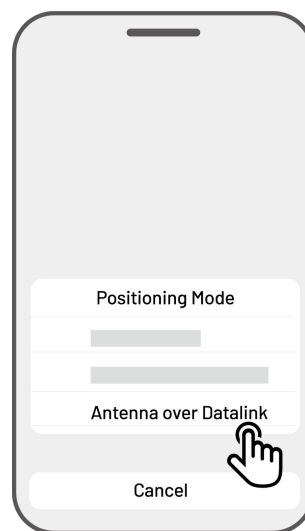

4. Return to the status information page and verify that the positioning mode displays '**Antenna over Datalink**', the RTK positioning status shows '**Fix**', and the RTK connection status shows '**Connected**'. Your setup is now complete.

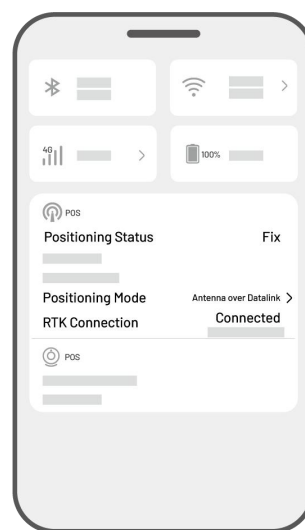

What to do when the robot's positioning is not Fix.

- Satellites (B): $L1 < 20, L2 < 20$
- Satellites (C): $L1 < 20, L2 < 20$
- Positioning status: Float

Measures:

Place the RTK reference station in an area with unobstructed views of the sky, without any physical obstructions within at least 5 m (16 feet). Alternatively, position the RTK reference station on a wall or roof.

- Signal quality (B): Bad or Weak

- Positioning status: Float

Measures:

Place the RTK reference station in an area with unobstructed views of the sky, without any physical obstructions within at least 5 m (16 feet). Alternatively, position the RTK reference station on a wall or roof.

- Satellite (B): L1:0, L2:0

- Satellite (C): L1:0, L2:0

- Positioning status: Single

Measures:

- ✓ Ensure the power supply to the RTK reference station is functioning normally.

- ✓ Verify that the indicator on the RTK reference station remains a constant green between the hours of 8:00-18:00 local time.

- ✓ Check for any defects within the RTK reference station, such as water leaks.

- ✓ Confirm that the radio antenna has been installed.

- ✓ Re-pair the RTK reference station and the robot to see if it can be fixed.

- ✓ If you replace the RTK reference station, pair the new station with the robot on the Mammotion app.

For more details, please see [**Add New RTK Reference Station after Replacing.**](#)

- Satellites (R) < 25

- Satellites (C): L1 < 20, L2 < 20

- Positioning status: Float

Measures:

Check if the area where the robot is situated, particularly when the robot is being charged, has tall trees/walls/metal barriers, etc.

- Signal quality (R): Bad or Weak

- Positioning status: Float

Measures:

- ✓ Check if the robot's current location is fully or partially covered.

- ✓ If the robot is positioned on the charging station, relocate it to a less obstructed area.

- ✓ If the robot is located on the perimeter/corner of the task area, adjust the perimeter/corner to ensure it is not covered.

- ✓ If the robot is located within the task area and has lost its positioning due to obstacles such as trees, iron tables or chairs, mark those obstacles as no-go zones.

- Satellites (R): 0
- Satellites (C): L1:0, L2:0
- Positioning status: None

Measures:

Check whether the robot is inside or if its rear is covered with metal. If the robot is faulty, please contact our after-sales team at <https://support.mammotion.com/portal/en/kb/articles/contact-us>

- Satellites (B): L1:0, L2:0
- Satellites (C): L1:0, L2:0
- Positioning status: Float
- Signal quality (B): None

Measures:

- ✓ Check if the RTK reference station has powered off.
- ✓ If the robot is too far from the RTK reference station, narrow the distance between the RTK reference station and the robot and retry.
- ✓ Verify if there are any malfunctions with the antenna, RTK reference station, or the robot receiver. If so, please contact our after-sales team at <https://support.mammotion.com/portal/en/kb/articles/contact-us>

4.11 Settings

Tap  to enter the Settings page.

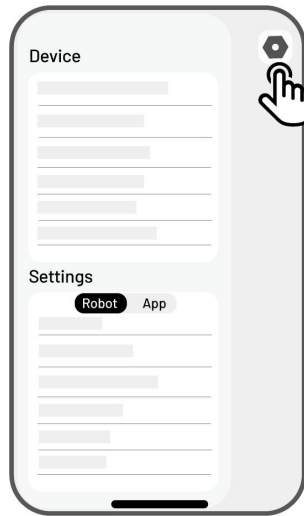

4.11.1 Device Settings

- **Device Information**

- ✧ **Device Name** – change the name of the robot.
- ✧ **Model** – indicates the product model name.
- ✧ **Sharing Management** – tap to view your sharing history and share your device with your family.
- ✧ **Robot Version** – check the firmware version of the robot.
- ✧ **Firmware Release Notes** – shows a log of updates and changes made to the device's firmware.
- ✧ **Network Settings** – set the robot network.
- ✧ **Upload Logs** – tap to send your issues and logs to Mammotion to target. You can attach a maximum of 5 images and 1 video.
- ✧ **Factory Reset** – tap to perform factory reset. All the logs and Wi-Fi passwords will be clear.
- ✧ **Maintenance** – shows the information on total mileage, mowing duration, battery cycle, and activation time.
- ✧ **Warranty** – shows the warranty duration and details.
- ✧ **Unbind** – tap to unbind the current robot. A set of the robot can only be associated with one

account and cannot be operated until it is bound. If you wish to transfer ownership of the robot, you must unbind it before proceeding.

- **Network Settings** – set the robot network.
- **Task Record** – shows the historical tasks that were completed and uncompleted.
- **Upload Logs** – tap to send your issues and logs to Mammotion to target. You can attach a maximum of 5 images and 1 video.

4.11.2 Robot Settings

- ✧ **Manual Operation** – tap to enter manual operation mode.
- ✧ **No mowing on rainy days** – when you enable this function, the robot will not mow if it rains.
- ✧ **Turnaround mode** – provides two ways to turnaround: Zero turn and Multi-point turn.

Zero Turn

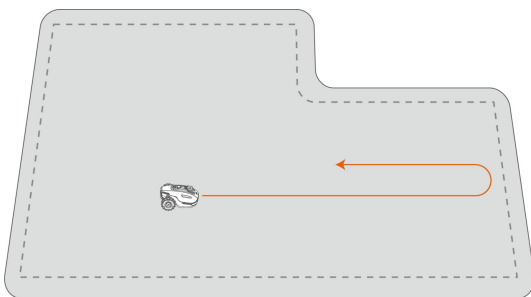

Multi-point Turn

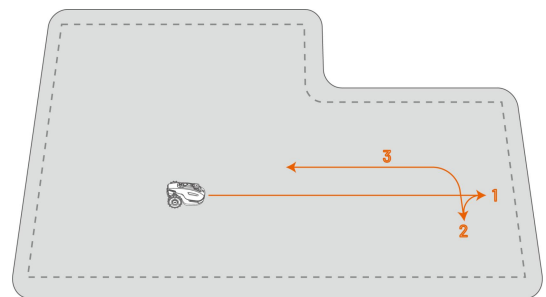

- ✧ **Recharge mode** – provides two ways to charge: Direct and Follow the perimeter. **Direct** means that the robot takes the shortest route to return to the charging station; **Follow the perimeter** means that the robot drives down the perimeter to the charging station.

Direct

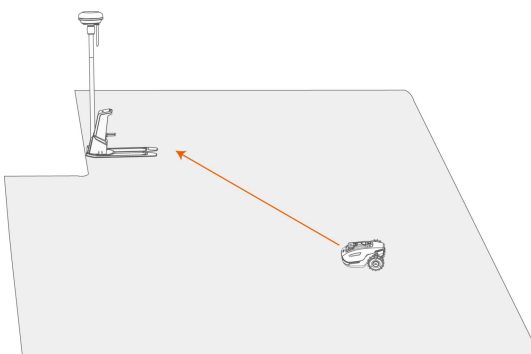

Follow the perimeter

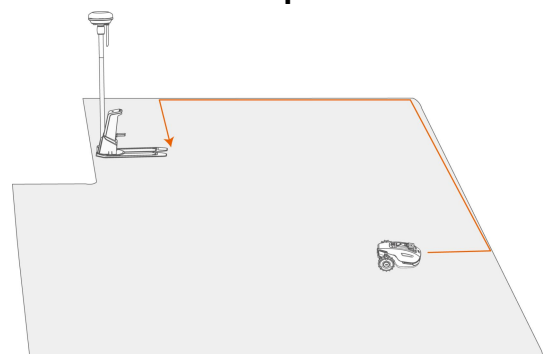

- ✧ **Wildlife Safe Mode** – tailored to minimize the risk to wildlife at night.
- ✧ **Side LED** – tap to turn on/off the side indicator of the robot.
- ✧ **Non-working Periods** – tap to set non-working period.
- ✧ **Vision Module Wiper** – tap to clean the vision camera.
- ✧ **Positioning Mode** – tap to switch positioning mode or reset RTK pairing code.
- ✧ **Delete Map** – tap to delete the existing map.
- ✧ **Relocate Charging Station** – tap to relocate the charging station. See [Relocate the charging station](#) for additional information.
- ✧ **Voice Settings** – tap to switch male and female voice.

Wildlife Safe Mode

Nighttime Safety Speed

When enabled, the robot's maximum speed in automatic mode at night is limited to below 0.3 m/s.

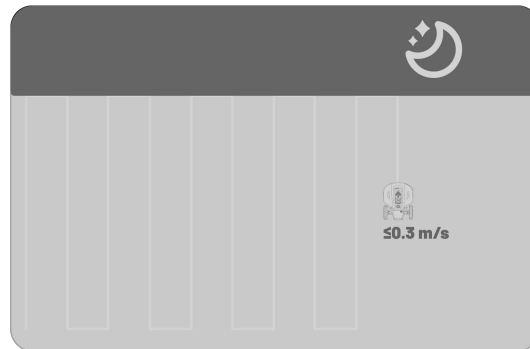

No Nighttime Task

When enabled, the robot will not perform any tasks at night. Active tasks will also pause and the robot will return to the charging station.

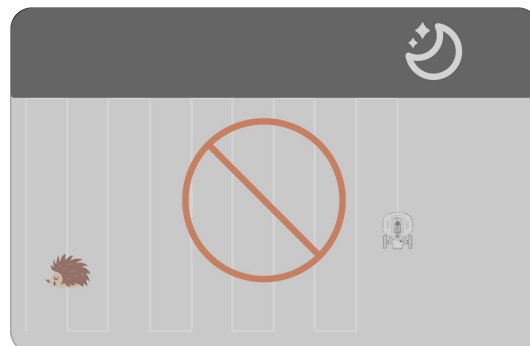

Relocate the charging station



NOTE

Please use the Relocate Charging Station feature while the robot is charging.

Generally, the charging station should be relocated if

- The charging station is moved.
 - The charging station is replaced.
 - The docking path has a significant incline.
 - The recharge process consistently fails.
1. Install the charging station in a proper place.
 2. Place the robot on the charging station and ensure the positioning status is fine.
 3. Select **Settings**  > **Relocate charging station**.

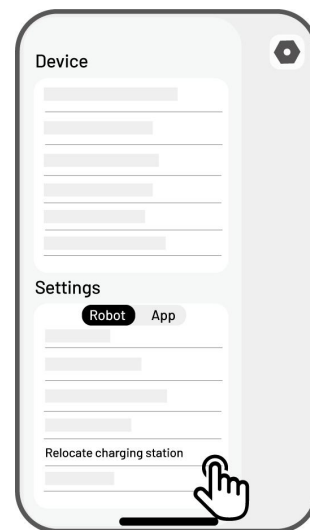

4.11.3 Recharge



NOTE

When performing the recharge function, the robot must be in the task area.

To perform recharge

- Tap  on the map page in Mamotion app, or
- Press the button  on the robot, then press  to guide the robot to the charging station.

4.12 Service Page

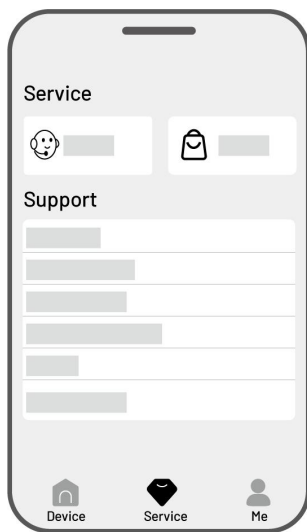

- **Help** – tap to access our customer service.
- **Store** – tap to go to Mammoth mall.
- **Academy** – tap to access user instructions.
- **Tutorial Videos** – tap to access tutorial videos.
- **User Manual** – tap to access the user manual.
- **Winter Maintenance** – tap to access the winter maintenance details.
- **FAQ** – shows common questions and answers.
- **About Us** – tap to access more information about Mammoth.

4.13 Me Page

- **Device Management and Sharing** – tap to share your devices.
- **Find My Device** – tap to track your device.
- **Alexa** – tap to link your Alexa account.
- **Google Home** – tap to link your Google Home account.
- **Guide** – toggle to on/off to show/hide guidelines.
- **Language** – switch language.
- **Upload Logs** – submit your issues and logs to Mammoth to target.
- **About Mammoth** – tap to view the app version, User Agreement, and Privacy Agreement.

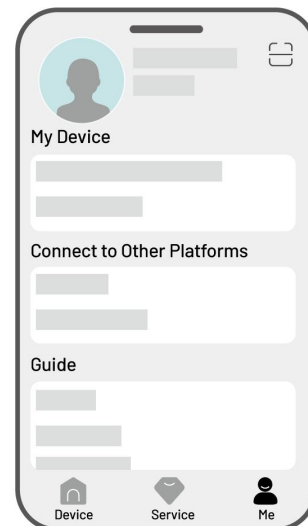

4.13.1 Share Your Device

Sharing your device allows the recipient to control and access device information, but they cannot share it further or use its anti-theft feature.

1. Go to the Me page and tap **Device management and sharing**.
2. Select your own device to share.
3. Tap **Share with people** to go on.
4. Select **Share via account** or **Share via QR code** to share your device.
 - **Share via account**
 - a. Tap **Share via account**.
 - b. Enter the account number that you want to share, then tap **Share**.
 - c. In the recipient's Mammotion app, tap **Agree** in the popup.
 - **Share via QR code**
 - a. Tap **Share via QR code** and a code will appear.
 - b. Use the recipient's Mammotion app to scan the QR code and tap **Agree** in the popup.

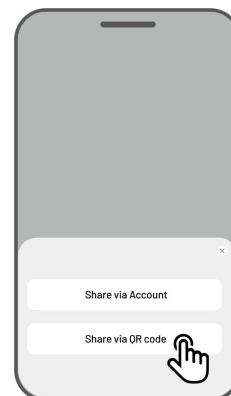
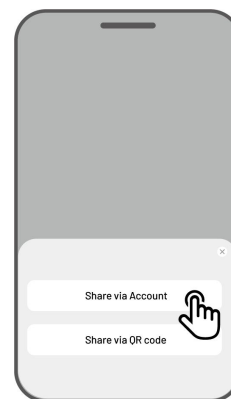
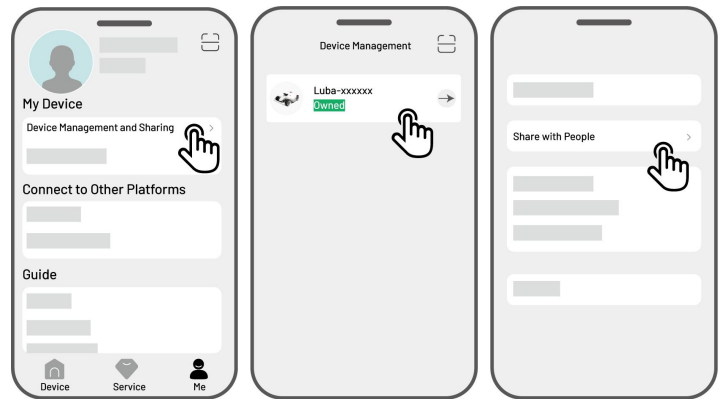

4.13.2 Stop Sharing Your Device

For Owner

1. Go to the Me page and tap **Device management and sharing**.
2. Select the device that you have shared.
3. Tap **Sharing management** to continue.
4. Select the corresponding sharing history and tap **Delete**.
5. Tap **Confirm** to revoke the recipient's access to the device.

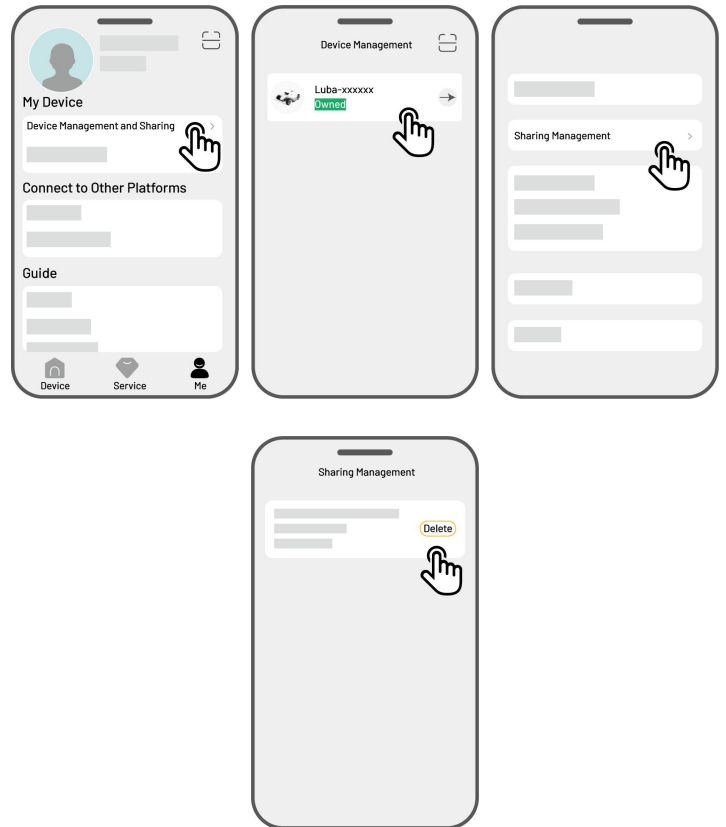

For Recipient

1. Go to the Me page and tap **Device management and sharing**.
2. Select the device that has been shared with you.

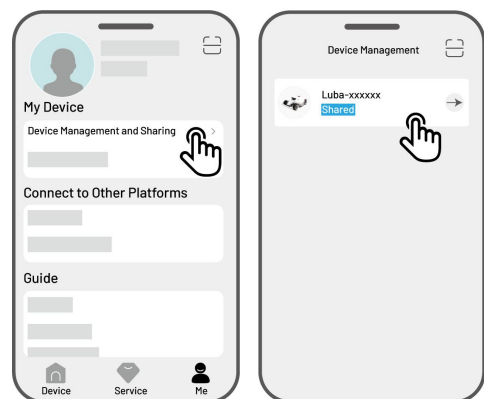

3. Tap **Delete**.
4. Tap **Confirm** to stop using the device. This action will not affect the owner's data.

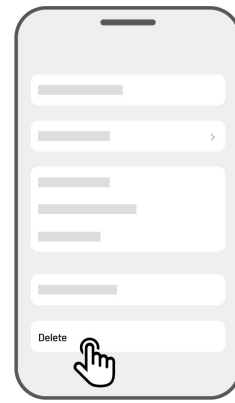

4.13.3 Find My Device

In the case that your robot or RTK reference station that has been bound with the Mammotion app is missing, go to **Me > Find my Device** page to track your device.

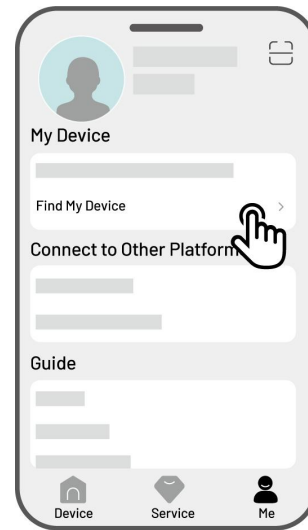

Tap the device to enter the next page where you can enable/disable **Location Notifications** and **Location Recorder**.

- **Location Notifications** – You will receive a push notification when the robot is more than 50 meters (164 feet) away from the task area after enabling it.
- **Location Recorder** – Record the location history of the robot after enabling it.

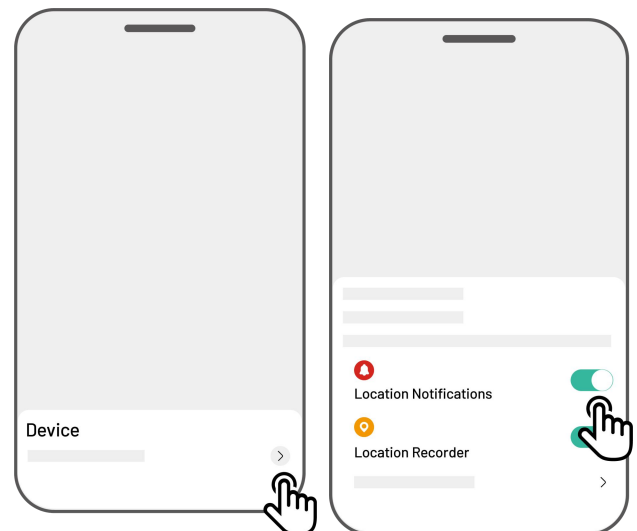

4.13.4 Link Your Alexa Account

NOTE



- Prior to starting a job using voice control, it is necessary to have created at least one task beforehand.
- In cases where more than 2 sets of robots are linked to the same Mammotion account, the voice command will be directed to the most recently bound robot by default.

1. Go to the **Me** page and tap on **Alexa**.
2. Select **YUKA** to proceed.
3. Tap **Link Alexa** to go to the authorization page.
4. Finally, tap **Link** to complete the operation.

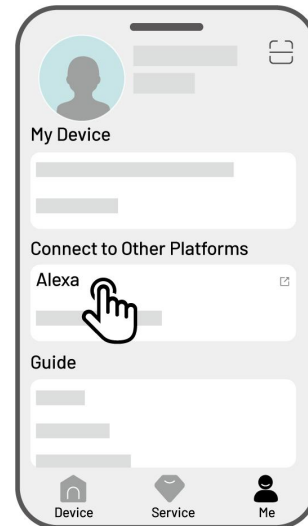

Once the linking is successful, you can control the robot with voice commands. Here are some examples for starting, pausing, stopping, recharging, and checking the status:

Working

- Alexa, ask YUKA to start working
- Alexa, ask YUKA to start task xx (xx means the name of the task you set)

Pause working

- Alexa, ask YUKA to pause
- Alexa, ask YUKA to hold on
- Alexa, ask YUKA to suspend

Continue working

- Alexa, ask YUKA to continue
- Alexa, ask YUKA to resume

Stop working

-Alexa, ask YUKA to stop working

-Alexa, ask YUKA to end the task

Recharge

-Alexa, ask YUKA to recharge

-Alexa, ask YUKA to go home

Check status

-Alexa, ask YUKA status

-Alexa, ask YUKA what it is doing

4.13.5 Link Your Google Home Account



NOTE

Prior to starting a job using voice control, it is necessary to have created at least one task beforehand.

1. Go to the **Me** page and tap on **Google Home**.
2. Tap **Link Google Home** to go to the authorization page.
3. Follow the instructions to complete the setup.

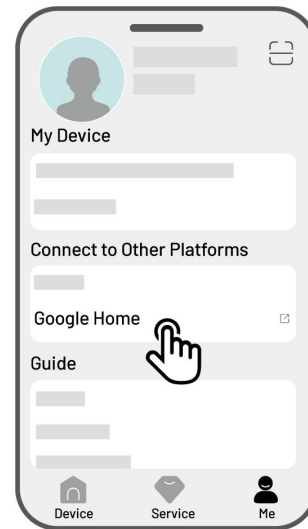

After linking succeeds, you can control the robot using voice commands, try the following commands:

Start working

- Hey Google, start mowing
- Hey Google, start the YUKA now
- Hey Google, let the YUKA start running
- Hey Google, make the YUKA start running

Pause working

- Hey Google, pause mowing
- Hey Google, pause the YUKA now
- Hey Google, let the YUKA pause
- Hey Google, make the YUKA pause

Continue working

- Hey Google, continue mowing

-Hey Google, let the YUKA continue

-Hey Google, make the YUKA continue

Stop working

-Hey Google, stop mowing

-Hey Google, stop the YUKA

-Hey Google, let the YUKA stop

-Hey Google, make the YUKA stop

Recharge YUKA

-Hey Google, dock the YUKA

-Hey Google, let the YUKA go home

-Hey Google, make the YUKA go home

Check status

-Hey Google, is the YUKA running?

5 Maintenance

To maintain optimal mowing performance and extend the lifespan of your robot, Mammotion advises performing regular inspections and maintenance weekly. For safety and effectiveness, always wear protective clothing such as trousers and work shoes; avoid wearing open sandals or going barefoot during maintenance.

5.1 Cleaning

WARNING



- Ensure the robot is completely powered off before beginning any cleaning work.
 - Always power off the robot before turning it upside down.
 - When turning the robot upside down, handle it with care to avoid damaging the vision module.
-

5.1.1 Clean Robot

Housing

Use a soft brush or a damp cloth to clean the robot's housing. Avoid using alcohol, gasoline, acetone, or other corrosive or volatile solvents, as they may damage the robot's appearance and internal components.

Bottom

Wear protective gloves while cleaning the chassis and cutting discs. Use a brush to remove debris. Check for blade damage and ensure that the blades and cutting discs can rotate freely. DO NOT use sharp objects to clean the bottom.

Front Wheel

Clean the front wheel using a brush or water hose. Remove the mud if any.

Rear Wheels

Regularly clean the rear wheels with a brush or water hose if they become too dirty.

Vision Camera

Wipe the vision camera lens with a microfiber cloth to remove any stains. A clean lens is crucial for the performance of the vision module.

5.1.2 Clean Charging Station

Use a brush and cloth to clean the infrared transmitter and the charging pin.

5.1.3 Clean RTK Reference Station

Wipe the RTK reference station with a cloth to remove any accumulated dirt.

5.2 Maintenance for Cutting Blades and Motor

WARNING



- Always wear protective gloves when inspecting, cleaning, or replacing the cutting blade.
 - DO NOT use an electrical screwdriver to tighten or loosen the cutting disc. Always use the correct screws and original blades approved by Mammotion.
 - Replace all cutting blades and their screws simultaneously to ensure a safe and effective cutting system.
 - DO NOT reuse the screws, which may cause serious injury.
-

- To ensure optimal performance during long-term storage, keep the hub motor shaft dry and clean. Regular maintenance of the motor shaft helps prevent dirt and moisture buildup, which can affect the motor's function. The motor has an expected lifespan of 1500 hours of operation.
- Blades are considered wear parts and should be replaced if they become severely worn. It is recommended to replace the cutting blades every 3 months or after 150 hours of use. For thicker grass, more frequent blade replacement may be necessary.
- Wet grass is more likely to stick to the blades and bottom of the robot, which can impair performance and lead to the need for more frequent cleaning. For optimal performance and long-term lawn health, it is recommended to avoid mowing during heavy rain or when the grass is excessively wet.

How to replace a cutting blade

1. Turn off the robot.
2. Place the robot on a soft, clean surface, ensuring it is in an upside-down position. Please take care not to press on the vision module.
3. Remove the old cutting blades with the included Phillips screwdriver.
4. Install the new cutting blades (**B**) using the included screws (**A**). Ensure that the blades can rotate freely and are securely installed.

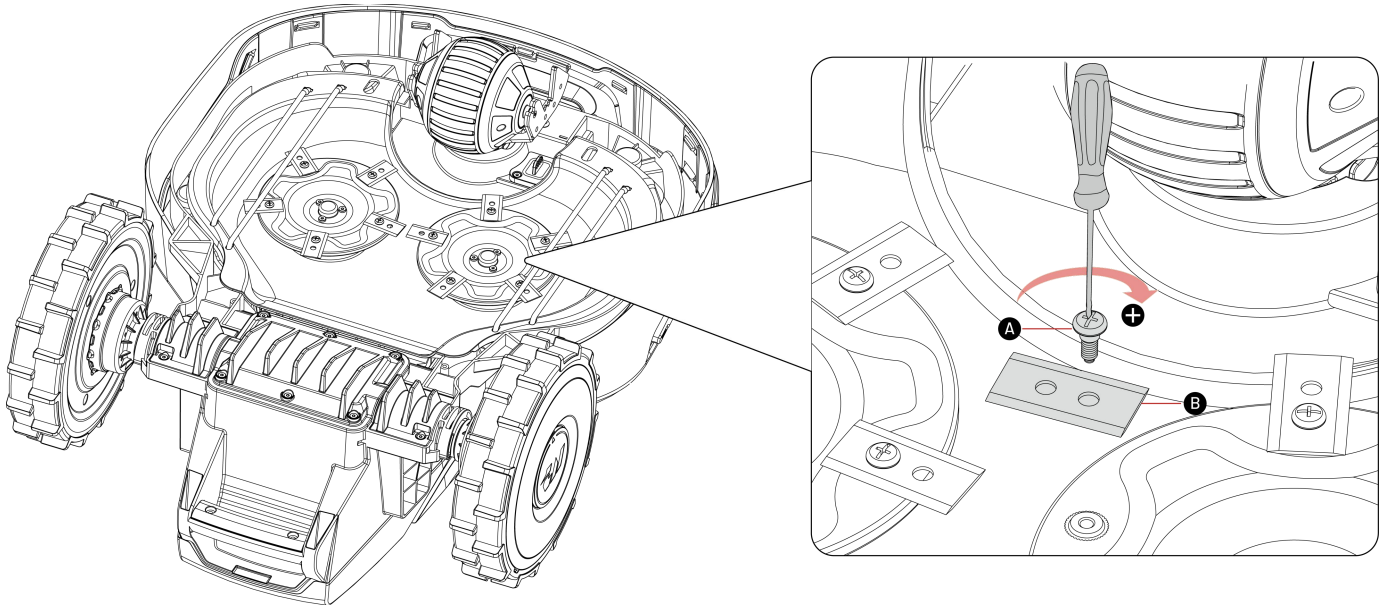

5.3 Battery Maintenance

- Maintain the battery fully charged before long-term storage to prevent over-discharge.
- Charge fully every 90 days, even if it is not in use.
- Ensure the charging ports on the robot are clean and dry before storing or charging.

5.4 Winter Storage

To ensure your robot is in optimal condition for the next mowing season, store the robot, charging station, and RTK reference station properly. If the ambient temperature drops below -20°C (-4°F) during winter, keep the robot, RTK reference station, and charging station indoors.

5.4.1 Store Robot

- Control the robot off the charging station, ensuring the robot has been fully charged.
- Power off the robot.
- Clean the robot (the housing, wheels, chassis, vision module, etc.) with a damp cloth or soft brush. You can wash the robot if necessary. DO NOT turn the robot upside down to clean its chassis with water.
- Leave the robot to get dry. DO NOT turn it upside down during this process.
- Apply anti-corrosion lubricant to the charging pads. DO NOT apply the chemicals to any other parts of the robot, especially metal contact areas, except for the connectors.
- Store the robot indoors.

5.4.2 Store Charging Station

- Disconnect the power supply.
- Remove the stakes.
- Use a brush and cloth to clean the charging station thoroughly.
- Remove the charging station and the power supply.
- Store the charging station and the power supply indoors.

In the next mowing season, reinstall the charging station, then relocate it (See [Relocate the charging station](#) for more information) and remap a channel between the charging station and the task area using the Mammotion app.

5.4.3 Store RTK Reference Station

If the ambient temperature is above -20°C (-4°F) in winter:

- Unplug the RTK reference station.
- Twine the RTK reference station cable around the station and tighten the protective cap.
- Cover the RTK reference station with a plastic bag or cover.

If you follow these steps and do not move the RTK reference station, you will not need to delete the map and remap for the next mowing season.

If the ambient temperature is below -20°C (-4°F) in winter:

If the RTK reference station is installed on the ground, follow the steps below:

- Delete the map in the Mammotion app.
- Unplug the RTK reference station.
- Remove the RTK reference station from the mounting pole.
- Remove the antenna.
- Use a cloth to clean the RTK reference station.
- Remove the mounting pole.

In the next season, reinstall the RTK reference station and remap in the Mammotion app.

If the RTK reference station is installed on the wall/roof, follow the steps below:

- Unplug the RTK reference station.
- Remove the RTK reference station from the wall mounting pole.
- Remove the antenna.
- Use a cloth to clean the RTK reference station.

In the next mowing season, reinstall the RTK reference station in its original position. There is no need to delete the map and remap as the location of the RTK reference station remains unchanged.

5.4.4 Store Sweeper Kit

- Power off the robot.
- Unplug the lawn sweeper kit.
- Reattach the port cover on the robot.
- Remove the sweeper kit from the robot.
- Clean the roller brush module with a brush.
- Rinse the surface and collection bag with a water hose.
- Allow the sweeper kit to dry thoroughly, then store it indoors.

6 Product Specifications

6.1 Technical Specifications

6.1.1 General Specifications

Parameters	YUKA		
	1000	2000	3000
Recommended Mowing Area	1,000 m ² (0.25 acre)	2,000 m ² (0.5 acre)	3,000 m ² (0.75 acre)
Max. Mowing Area	1,600 m ² (0.4 acre)	2,800 m ² (0.7 acre)	4,000 m ² (1 acre)
Max. multi-zone Management	10	20	30
Engine	2 Wheel-drive		
Max. Climbing Ability	Without sweeper: 45% (24°) With sweeper: 18% (10°)		
Vertical Obstacle Passing Ability	5 cm (2 in)		
Cutting Width	32 cm (12.6 in)		
Cutting Height Adjustment	For US: 30-100 mm (1.2-4 in) For EU/UK/AU: 20-90 mm (0.8-3.5 in)		
Charging Time	100 min		220 min
Mowing Time per Charge	65 min		130 min
Auto-recharge	YES		
Charging Station	CHG2400		
RTK Reference Station	RTK301		
RTK Signal Coverage	Net: 5 km (3.1 miles) Datalink: 120 m (394 feet)		
Positioning & Navigation	UltraSense AI Vision & RTK		

Parameters	YUKA		
	1000	2000	3000
Obstacle Avoidance	UltraSense AI Vision & Physical Bumper		
Voice Control	Alexa & Google Home		
Vision Monitoring	YES		
Connectivity	4G & Bluetooth & Wi-Fi		
Noise Level	60 dB		
A weighted sound power	L _{WA} =66dB, K _{WA} =3dB		
A weighted sound pressure	L _{PA} =58dB, K _{PA} =3dB		
Waterproof	Robot: IPX6 Charging Station: IPX6 RTK Reference Station: IPX6		
Rain Detection	YES		
OTA Upgrade	YES		
GPS Theft Tracking	YES		
Geo-fence Alarm	YES		
Vision Geo-fence	YES		
Net Weight	16.3 kg (36 lbs.)		17.2 kg (38 lbs.)
Dimensions (L x W x H)	648 x 519 x 330 mm (25.5 x 20.4 x 13 in)		

6.1.2 YUKA Onboard Operating Bands Specifications (EU)

Operating Frequency		Maximum Transmitter Power
LORA	863.1.-869.85MHz	<13.98dBm
Bluetooth	2400-2483.5MHz	<20dBm
Wi-Fi	2400-2483.5MHz	<20dBm
	5500-5700MHz	<20dBm
	5745-5825MHz	<13.98dBm
GSM900	880-915MHz(Tx); 925-960MHz (Rx)	35dBm
GSM1800	1710-1785MHz(Tx); 1805-1880MHz	32dBm
WCDMA Band I	1920-1980MHz(Tx); 2110-2170MHz (Rx)	25dBm
WCDMA Band VIII	880-915MHz(Tx); 925-960MHz (Rx)	25dBm

LTE Band 1	1920-1980MHz(Tx); 2110-2170MHz (Rx)	25dBm
LTE Band 3	1710-1785MHz(Tx); 1805-1880MHz (Rx)	25dBm
LTE Band 7	2500-2570MHz(Tx); 2620-2690MHz (Rx)	25dBm
LTE Band 8	880-915MHz(Tx); 925-960MHz (Rx)	25dBm
LTE Band 20	832-862MHz(Tx); 791-821MHz (Rx)	25dBm
LTE Band 28	703-748MHz(Tx); 758-803MHz (Rx)	25dBm
LTE Band 38	2570-2620MHz(Tx); 2570-2620MHz (Rx)	25dBm
LTE Band 40	2300-2400MHz(Tx); 2300-2400MHz (Rx)	25dBm
GNSS	1559-1610MHz	N/A

6.1.3 RTK Reference Station Operating Bands Specifications (EU)

Operating Frequency		Maximum Transmitter Power
LORA	863.1.-869.85MHz	<13.98dBm
Bluetooth	2400-2483.5MHz	<20dBm
Wi-Fi	2400-2483.5MHz	<20dBm
GNSS	1559-1610MHz	N/A

6.1.4 Sweeper Kit Specifications

Parameters	Specifications
Dimensions (L x W x H)	650 x 420 x 390 mm (25.6 x 16.5 x 15.4 in)
Container Capacity	22 Liters
Sweeper Width	250 mm (9.8 in)
Operating Temperature	0-40°C (32-104°F)
Storage Temperature	-10-50°C (14-122°F)

6.1.5 Battery Specifications

Parameters	YUKA		
	1000	2000	3000
Battery charger	TS-A081-2703002 Input: 100-240V~, 50/60Hz, 2.0A Output: 27Vdc, 3.0A, 81W		
Battery pack	21.6Vdc, 4.5Ah		
Battery capacity	4.5Ah		
Temperature range for charging is 4-45 °C / 39-113 °F. Too high temperatures might cause damage to the product.			
WARNING: For the purposes of recharging the battery, only use the detachable supply unit provided with this appliance.			

6.2 Fault Codes

The app notification displays common fault codes along with their causes and troubleshooting steps.

Here lists the most common issues.

Fault Codes	Causes	Solutions
316	The left cutting disc motor is overheating.	The robot will return to normal once the motor has cooled down. This process may take several minutes.
318	The sensor for the left cutting disc motor has failed.	Restart the robot. If the issue persists after a few times of restart, contact the after-sale team.
323	The right cutting disc motor is overloaded.	Check if the cutting disc is jammed and clear it if necessary. Alternatively, raise the cutting height.
325	The right cutting disc motor fails to start.	Check whether the cutting disc is jammed. If not, restart the robot. If the issue persists after a few times of restart, contact the after-sale team.
326	The right cutting disc motor is overheating.	Restart the robot. If the issue persists after a few times of restart, contact the after-sale team.
328	The sensor for the right cutting disc motor has failed.	Restart the robot. If the issue persists after a few times of restart, contact the after-sale team.
1005	Low battery	The robot will continue working after the battery is charged to 80%.
1300	The positioning status is poor.	Await the robot's repositioning.

Fault Codes	Causes	Solutions
1301	The charging station has been moved.	Relocate the charging station.
1420	Timeout occurred while retrieving wheel speed data.	Restart the robot. If the issue persists, contact the after-sale team.
2713	Charging has been stopped due to low battery voltage.	Restart the robot. If the issue persists after a few times of restart, contact the after-sale team.
2726	The battery is overcharged.	Stop charging immediately. If overcharging occurs frequently, contact the after-sale team.
2727	The battery is over discharged.	Recharge the robot.

7 Warranty

Shenzhen Mammotion Innovation Co., Ltd warrants that this product will be free from material and workmanship defects under normal use in accordance with the product materials published by Mammotion during the warranty period. The published product materials include but not limited to user manual, quick start guide, maintenance, specifications, disclaimer, in-app notifications, etc. The warranty period varies among different products and parts. Check the table below:

Component	Warranty
Host and Core	3 Years
Battery	
Spare parts (Charging station, RTK reference station)	

If the product does not function as warranted during the warranty period, please contact Mammotion customer service for instructions.

- For products purchased from a local dealer, kindly reach out to the dealer first.
- Users must present a valid proof of purchase, receipt, or order number (for Mammotion Direct Sales). The Serial Number of the product is crucial for initiating warranty service.
- Mammotion will make every effort to address concerns through phone calls, email, or online chat.
- In some cases, Mammotion may advise you to download or install specific software updates.
- If issues persist, you may need to send the product to Mammotion for further assessment or to a local Mammotion-appointed service center.
- The warranty period for the product commences from the original date of purchase indicated on the sales receipt or invoice.
- For pre-ordered products, the warranty period begins from the shipping date from the local

warehouse.

- Mammotion will need users to arrange the shipment by themselves if users would like to send the products to local service center or Mammotion factory for further diagnosis. Mammotion will repair or replace and send back to users at no cost if the problem falls under the warranty. If not, Mammotion or designated service center may charge a fee accordingly.

Here puts some examples of faults that warranty will not cover:

- Failure to follow the instructions outlined in the user manual.
- If the product arrives damaged during shipment and is not rejected upon delivery, or if no official documentation confirming the damages is provided by the shipping company. Inability to provide evidence of damage occurring during transit.
- Product malfunction due to accidents, misuse, abuse, natural disasters like floods, fires, earthquakes, exposure to food or liquid spills, incorrect electrical charging, or other external factors.
- Damage resulting from using the product in ways not permitted or intended as specified by Mammotion.
- Modification of the product or its components that significantly alters functionality or capabilities without obtaining written permission from Mammotion.
- Loss, damage, or unauthorized access to your data.
- Signs of tampering or alteration on product labels, serial numbers, etc.
- Failure to provide a valid proof of purchase from Mammotion, such as a receipt or invoice, or if there are suspicions of forgery or tampering with the documentation.

8 Compliance

FCC Compliance Statements

This device complies with Part 15 of the FCC Rules. Operation is subject to the following two conditions: (1) this device may not cause harmful interference, and (2) this device must accept any interference received, including interference that may cause undesired operation.

Caution: Changes or modifications not expressly approved by the party responsible for compliance could void the user's authority to operate the equipment.

Note: This equipment has been tested and found to comply with the limits for a Class B digital device, pursuant to Part 15 of the FCC Rules. These limits are designed to provide reasonable protection against harmful interference in a residential installation. This equipment generates, uses and can radiate radio frequency energy and, if not installed and used in accordance with the instructions, may cause harmful interference to radio communications. However, there is no guarantee that interference will not occur in a particular installation.

If this equipment does cause harmful interference to radio or television reception, which can be determined by turning the equipment off and on, the user is encouraged to try to correct the interference by one or more of the following measures:

- Reorient or relocate the receiving antenna.
- Increase the separation between the equipment and receiver.
- Connect the equipment into an outlet on a circuit different from that to which the receiver is connected.
- Consult the dealer or an experienced radio/TV technician for help.

ISED Compliance Statements

This device contains licence-exempt transmitter(s)/receiver(s) that comply with Innovation, Science and Economic Development Canada's licence-exempt RSS(s). Operation is subject to the following two conditions:

(1) This device may not cause interference.

(2) This device must accept any interference, including interference that may cause undesired operation of the device.

This equipment complies with IC RSS-102 radiation exposure limits set forth for an uncontrolled environment.

L'émetteur/récepteur exempt de licence contenu dans le présent appareil est conforme aux CNR d'Innovation,

Sciences et Développement économique Canada applicables aux appareils radio exempts de licence.

L'exploitation est autorisée aux deux conditions suivantes:

(1) L'appareil ne doit pas produire de brouillage;

(2) L'appareil doit accepter tout brouillage radioélectrique subi, même si le brouillage est susceptible d'en compromettre le fonctionnement.

Cet équipement est conforme aux limites d'exposition aux radiations IC CNR-102 établies pour un environnement non contrôlé.

RF Exposure Compliance

This equipment complies with FCC/IC RSS-102 radiation exposure limits set forth for an uncontrolled environment. This transmitter must not be co-located or operating in conjunction with any other antenna or transmitter. This equipment should be installed and operated with minimum distance 20 cm between the radiator and your body.

Cet équipement est conforme aux limites d'exposition aux radiations IC CNR-102 établies pour un environnement non contrôlé.

Cet émetteur ne doit pas être colocalisé ou fonctionner en conjonction avec une autre antenne ou un autre émetteur. Cet équipement doit être installé et utilisé avec une distance minimale de 20 cm entre le radiateur et votre corp.

Simplified EU Declaration of Conformity

Hereby, Shenzhen Mammotion Innovation Co., Limited declares that the radio equipment type [Model:1000/2000/3000] is in compliance with Directive 2014/53/EU.

The full text of the EU declaration of conformity is available at the following internet address:

<https://mammotion.com/pages/eu-declaration-of-conformity>.



MAMMOTION

SHENZHEN MAMMOTION INNOVATION CO., LTD

www.mammotion.com

Copyright © 2025, MAMMOTION All Rights Reserved.